



**Capital Area Transportation Authority  
4615 Tranter Street  
Lansing, MI 48910**

**REQUEST FOR QUOTE  
BUS STOP IMPROVEMENTS  
RFQ 2021-539**

<b>1. SOLICITATION No:</b> RFQ 2021-539	<b>2. ISSUE DATE:</b> September 27, 2021
<b>3. FOR INFORMATION CONTACT</b> <b>NAME:</b> Jason Mele <b>E-MAIL:</b> <a href="mailto:jmele@cata.org">jmele@cata.org</a>	<b>PHONE:</b> 517.394.1100 ext. 2532

**4. DESCRIPTION:**

The Capital Area Transportation Authority ("CATA") in Lansing, Michigan, is requesting pricing for **BUS STOP IMPROVEMENTS** in accordance with the Scope of Work as described in Exhibit A.

**Written Questions are Due to CATA by: September 30, 2021 by 2:00 P.M. Eastern Time**

ALL QUESTIONS MUST BE SUBMITTED VIA EMAIL TO: Jason Mele ([jmele@cata.org](mailto:jmele@cata.org))

**CATA's Responses to Questions Released: October 4, 2021**

**QUOTES MUST BE SUBMITTED VIA EMAIL TO:**  
Capital Area Transportation Authority  
Attn: Jason Mele, Procurement Specialist  
4615 Tranter Street  
Lansing, Michigan 48910

Quotes for "BUS STOP IMPROVEMENTS" submitted to Capital Area Transportation Authority, Lansing, Michigan will be received at [jmele@cata.org](mailto:jmele@cata.org) until September 30, 2021, 2:00 P.M. Eastern Time. Emails received at 2:01 P.M. Eastern Time or later, will be considered NON-RESPONSIVE.

CATA email accepts up to 50MB. It is the vendor's responsibility to ensure each email sent to CATA does not exceed 50MB.

**5. QUOTES DUE BY: THURSDAY, OCTOBER 7, 2021 at 2:00 P.M. EASTERN TIME**

**6. FIRM OFFER PERIOD:** Offers shall remain firm for a period of **120** calendar days from the date specified above or as amended.

**7.** If this Quote is accepted within the period specified above, Bidder agrees to fully provide the goods and/or services covered by this solicitation at the prices and timelines specified in the solicitation.

**8. The following Exhibits, if indicated, are included in this solicitation:**

<input checked="" type="checkbox"/>	EXHIBIT A – Scope of Work	<input checked="" type="checkbox"/>	EXHIBIT B – Pricing Schedule	<input checked="" type="checkbox"/>	EXHIBIT C – Submittal Checklist
<input checked="" type="checkbox"/>	EXHIBIT D – Iran Economic Sanctions Act Certificate	<input checked="" type="checkbox"/>	EXHIBIT E – Bidder's Offer & Guarantees	<input checked="" type="checkbox"/>	EXHIBIT F – Debarment & Suspension - Primary
<input checked="" type="checkbox"/>	EXHIBIT G – Debarment & Suspension – Subcontractor	<input checked="" type="checkbox"/>	EXHIBIT H – DBE Participation Form	<input checked="" type="checkbox"/>	EXHIBIT I – CATA Terms & Conditions
<input checked="" type="checkbox"/>	EXHIBIT J – Wage Determination				

## EXHIBIT A SCOPE OF WORK

**BASIS OF AWARD: The award of this order is based on the lowest responsive and responsible bidder(s) as determined by the Capital Area Transportation Authority (CATA).**

**Please Note:** This bid package and any amendments are available at [www.cata.org](http://www.cata.org). Please continue checking the website for any updates or amendments.

### 1. Objectives

The specific objectives for this Project are to secure a contract for bus stop improvements.

### 2. General Provisions

- a) The Contractor shall furnish all labor, tools and materials necessary for the bus stop improvements as listed in this Scope of Work.
- b) The Contractor shall provide CATA's Project Manager with a work schedule.
- c) The Contractor assumes full responsibility for protection and safekeeping of materials and equipment on-site.
- d) All work must conform to all state and local construction regulations. The Contractor will be responsible for obtaining and paying for all required permits. The Contractor will be responsible for coordinating and scheduling all work with CATA Staff, Miss Dig and local municipalities and jurisdictions.
- e) The Contractor will notify CATA's Project Manager of any findings during the project and submit a cost proposal for any additional work required. No additional work shall commence until approved by CATA's Project Manager.
- f) The Contractor will be responsible for clean up at the end of each work day.
- g) BID BOND INFORMATION – a 5% Bid Bond is required to be submitted with all vendor quotes. If awarded the contract a 100% Payment and Performance Bond are required and must be submitted to CATA within five (5) business days of award.
- h) All required payroll records and required documents to comply with the requirements of Davis Bacon Act. Proper documentation will be required in order to receive payment.

### 3. Service Period

CATA intends to award a firm, fixed price contract.

### 4. Scope of Work

The purpose of this Request for Quote (RFQ) is to procure a qualified, responsive and responsible Contractor to remove, replace and or install ADA accessible concrete pad(s). The Contractor will be responsible for removing existing concrete pad(s), pouring concrete pad(s), grading and landscaping at existing stop locations.

Contractor, at the direction of CATA's Facilities Manager, shall provide Bus Stop Improvements accordance with the specifications, tasks, and scope of work set forth in Exhibit A. It is the sole responsibility of Contractor to read the specifications and understand them. Contractor shall construct concrete pads according to attached Bus Stop Information (*see Attachment A*). Site plans are not to scale and are only meant to be used as a visual guide for the construction of the concrete pads. It is the Contractor's responsibility to verify all dimensions.

#### Bus Stop Site Locations:

SBD Cedar past American	6699 S. Cedar St. Lansing, MI 48911
WBD Kalamazoo past Pine	600 W. Kalamazoo St. Lansing, MI 48933
EBD Grand River past Marsh	1931 Grand River Ave. Meridian Township, MI 48864
WBD Grand River past Marsh	2011 Grand River Ave. Okemos, MI 48864
WBD Grand River past Hagadorn	1375 Grand River Ave. East Lansing, MI 48823
SBD Harrison before Crescent	S. Harrison Rd. East Lansing, MI 48823
EBD Malcolm X past Pennsylvania	1036 E. Main St. Lansing, MI 48912

SBD Pleasant Grove past Holmes	3420 Pleasant Grove Rd. Lansing, MI 48910
NBD Pleasant Grove before Holmes	3427 Pleasant Grove Rd. Lansing, MI 48910
SBD Aurelius at Storage Sense	5600 N. Aurelius Rd. Lansing, MI 48911
NBD Aurelius at Enterprise	5901 N. Aurelius Rd. Lansing, MI 48911
SBD Aurelius past Enterprise	5900 N. Aurelius Rd. Lansing, MI 48911
NBD Aurelius past Sports Complex	5727 N. Aurelius Rd. Lansing, MI 48911
SBD Collins past Dunckel	4460 Collins Rd. Lansing, MI 48924

Site plans are not to scale and are only meant to be used as a visual guide for the construction of the concrete pads. It is the Contractor's responsibility to verify all dimensions. (See *Attachment A*)

#### Site Specifications:

- All concrete pads will be a minimum of 6" thick continuously with 6 x 6 standard steel mesh.
  - All concrete shall have a compressive strength of 4000 psi.
  - All expansion joints at existing pavement require speed dowels, per attached drawing (see *Attachment B*).
  - Concrete control joints will be hand-tooled to at least ¼ of concrete thickness, or a minimum of 1 1/2" or saw cut.
  - Finish pads to a non-slip surface with a broom finish, free from defects, vandalism, graffiti and blemishes.
  - Concrete pads shall have 1/8" per foot of slope to provide for water run-off.
  - Concrete pads will be set on a level and stable 4" base of 21 AA gravel that has been properly compacted to 95% density.
  - It shall be the Contractor's responsibility to repair or reroute all lawn irrigation lines in the affected area.
  - It shall be the Contractor's responsibility to backfill with screened topsoil and reseed grass with straw or straw blanket if slope requires to all areas affected by site construction.
  - All work must meet the requirements of the American Disabilities Act (ADA). The Contractor is responsible to visit each site location to determine the work required to meet the ADA. ADA requires no more than an 8.3% grade (1" per foot) for 20' with a minimum 5' x 5' resting area with no more than a 2% grade (¼" per foot). Bus boarding area pads require a minimum 5' x 5' clear boarding area with no more than 2% grade. Bus stop bench and shelter pads must be poured with no more than 2% grade.
  - Contractor is responsible for replacing any and all concrete that is not in ADA compliance in regards to the specific site.
  - Contractor shall contact Project Manager after forms are set before pouring.
  - Contractor is responsible for protecting any existing concrete and replacing any damaged concrete due to construction.
  - Contractor is responsible for de-watering.
  - Contractor to clean up all job debris, including removal and disposal of all debris.
  - Contractor is responsible for all traffic warning and road signs required to perform this work. This cost and all other costs must be included in their bid.
  - Contractor assumes full responsibility for protection and safekeeping of materials and equipment on-site. Barricades must be placed around each excavation and concrete pour. The construction site must be made safe and hazard free at all times until the work is completed. The Contractor shall be responsible for and the repair of any vandalism that may occur to the shelter pads while the cement is still wet.
  - Refer to Attachment B, joint specifications.
  - If existing appurtenances or utilities are found to interfere with the permanent facilities being constructed, the Contractor shall immediately notify CATA's Project Manager.
  - The Contractor will notify the CATA Project Manager of any findings during the project and submit a cost proposal for any additional work required. No additional work shall commence until approved by the Project Manager.
  - If necessary Contractor is responsible for all traffic warning and road signs required to perform this work. This cost and all other costs must be included in their bid.
  - Concrete shall be cured in accordance with ACI 301 procedures and as described herein. Water loss from new concrete will be limited to a rate of 1 lb./sq. ft. per 72 hours. Protect freshly placed concrete from premature drying and excessive cold or hot temperatures. Comply with ACI 306.1 for cold-weather protection and ACI 301 for hot-weather protection during curing
  - The sodium silicate base curing compounds that follow are compatible with the CATA's preferred sealer, most resilient floor covering adhesives, and many paint finishes.
  - 1. "Gardseal"; Lambert Corporation 2. "Sonosil"; Sonnebore Building Products Div. (BASF Building Systems)
5. CATA requires all work to be completed on or before, Sunday, November 14, 2021 @ 5:00 P.M. Eastern Time. NOTE: The allotted time is sufficient to complete the work. Therefore, no additional time will be allotted.

6. This solicitation does not obligate CATA to contract for the services specified herein. CATA reserves the right to remove and otherwise modify the site locations.
7. Vendor to provide CATA with a project schedule.
8. The Contractor must submit certified payroll with each invoice. All work done under the Contract resulting from this RFQ must comply with Davis-Bacon Requirements (if applicable).
9. Payment shall be made as follows; paid upon completion of project and receipt of certified payroll records (for prevailing wage).
10. Permits and Approvals (if applicable) – All work must conform to all state and local construction regulations.
  - a) The Contractor will be responsible for obtaining all necessary permits.
  - b) The Contractor will be responsible for coordinating and scheduling all work with CATA Staff, Miss Dig and local municipalities and jurisdictions.
  - c) The Contractor will be responsible for scheduling inspection and must obtain approval for completed work before submitting invoice. Copies of approval for completed work must accompany relevant invoices.
  - d) The Contractor will be responsible for payment of all permits and inspections.
11. The Contractor shall provide a minimum of a thirty (30) day warranty against defects of materials, services, and workmanship.
12. Price quoted will include all fees. Prices should be based on CATA's status as a tax exempt, municipal government agency.
13. Each Contractor should make every effort to include Disadvantaged Business Enterprises in this project. CATA has a Disadvantaged Business Enterprise goal of 2.57%.

**END OF THIS SECTION**

### ATTACHMENT A

Site plans are not to scale and are only meant to be used as a visual guide for the construction of the concrete pads. It is the Contractor's responsibility to verify all dimensions.

## BUS STOP INFORMATION

# 1

Date 9-24-18

Route 8 Inbound      Outbound X Trapeze ID 4733

GPS Latitude 42.66087 Longitude 84.53835 Capital Asset #     

Nearest Crossroads Cedar St / American hwy  
4611 S Cedar St. 48511

Landmark-Corner / direction from Intersection South of American hwy

#### Amenities at location

New Bus Stop / Shelter  Service Mount Base  In-Ground Base

Bench

Ash Try

Trash Receptacle / Pole Mount  15 Gal  30 Gal  50 Gal

Install Information Sign / Type  Quantity  Size

Other /     

Digital Photograph Taken Yes  No  Photo #     

Shelter/bench on private property or in right of way     

Shelter Make, Model and Size     

Cement Size      Square Footage     

Special Remarks 5'x8' pad at 1% leaving roughly a 5" curb cap

#### Drawing Layout

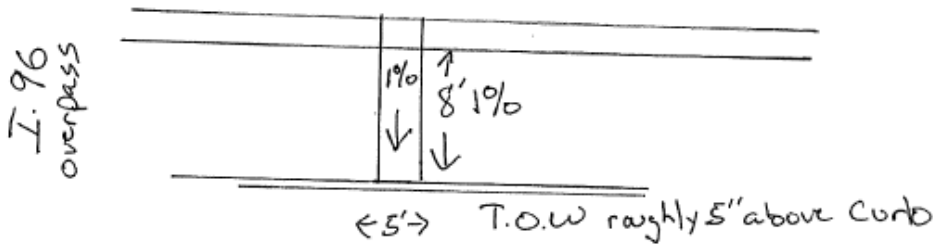



7

### BUS STOP INFORMATION

Date 9-27-18  
 Route 9 Inbound \_\_\_\_\_ Outbound X Trapeze ID 3046  
 GPS Latitude 40.73007 Longitude 084.56073 Capital Asset # \_\_\_\_\_

Nearest Crossroads Pine St / Kalamazoo  
600 W Kalamazoo  
 Landmark-Corner / direction from Intersection \_\_\_\_\_

Amenities at location  
 New Bus Stop / Shelter  Service Mount Base  In-Ground Base \_\_\_\_\_  
 Bench \_\_\_\_\_  
 Ash Trv \_\_\_\_\_  
 Trash Receptacle / Pole Mount \_\_\_\_\_ 15 Gal \_\_\_\_\_ 30 Gal \_\_\_\_\_ 50 Gal \_\_\_\_\_  
 Install Information Sign / Type \_\_\_\_\_ Quantity \_\_\_\_\_ Size \_\_\_\_\_  
 Other / \_\_\_\_\_

Digital Photograph Taken Yes \_\_\_\_\_ No \_\_\_\_\_ Photo # \_\_\_\_\_  
 Shelter/bench on private property or in right a way \_\_\_\_\_  
 Shelter Make, Model and Size \_\_\_\_\_  
 Cement Size \_\_\_\_\_ Square Footage \_\_\_\_\_

Special Remarks 7'6" x 20' pad at 1% leaving a 2" curb cap  
remove 5'6" x 13'6" pad and 3x2 connector

Drawing Layout:

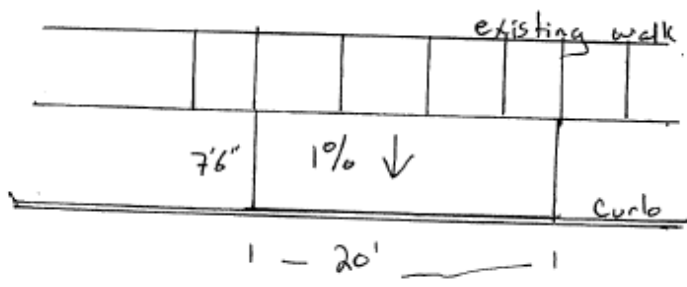

7

Google Maps 600 W Kalamazoo St



11

### BUS STOP INFORMATION

Date 9-27-18

Route 22 Inbound  Outbound  Trapeze ID 4285

GPS Latitude 42.72014 Longitude 084.41886 Capital Asset # \_\_\_\_\_

Nearest Crossroads EBD Gr. River Past Marsh 1931 M-43 / 1931 Grand River Ave (Meridian Township)

Landmark-Corner / direction from Intersection \_\_\_\_\_

Amenities at location

New Bus Stop / Shelter  Service Mount Base  In-Ground Base   
 Bench  
 Ash Trv  
 Trash Receptacle / Pole Mount  15 Gal  30 Gal  50 Gal  
 Install Information Sign / Type \_\_\_\_\_ Quantity \_\_\_\_\_ Size \_\_\_\_\_  
 Other / \_\_\_\_\_

Digital Photograph Taken Yes  No  Photo # \_\_\_\_\_

Shelter/bench on private property or in right a way \_\_\_\_\_

Shelter Make, Model and Size \_\_\_\_\_

Cement Size \_\_\_\_\_ Square Footage \_\_\_\_\_

Special Remarks 5' x 18' Connector at 1.1%

Drawing Layout:

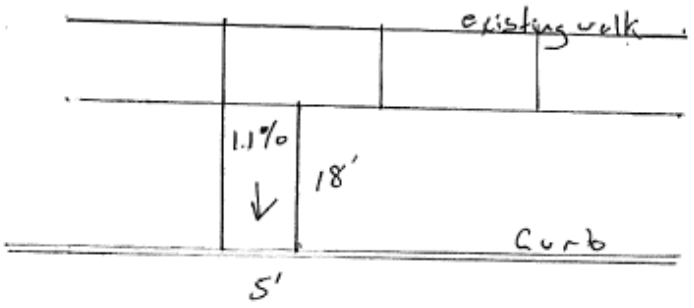

Google Maps 1931 M-43



12

### BUS STOP INFORMATION

Date 9-27-18

Route 1,23 Inbound  Outbound  Trapeze ID 1712

GPS Latitude 42.72087 Longitude 084.42088 Capital Asset # \_\_\_\_\_

Nearest Crossroads WBD Gr. River Post Marsh

Landmark-Corner / direction from Intersection 2011 M-43 / 2011 Grand River Ave. Okemos

Amenities at location

New Bus Stop / Shelter  Service Mount Base  In-Ground Base   
 Bench  
 Ash Trv  
 Trash Receptacle / Pole Mount  15 Gal  30 Gal  50 Gal  
 Install Information Sign / Type \_\_\_\_\_ Quantity \_\_\_\_\_ Size \_\_\_\_\_  
 Other / \_\_\_\_\_

Digital Photograph Taken Yes  No  Photo # \_\_\_\_\_

Shelter/bench on private property or in right a way \_\_\_\_\_

Shelter Make, Model and Size \_\_\_\_\_

Cement Size \_\_\_\_\_ Square Footage \_\_\_\_\_

Special Remarks SXS landing at 1% 13' connector at 5.4%

Drawing Layout:

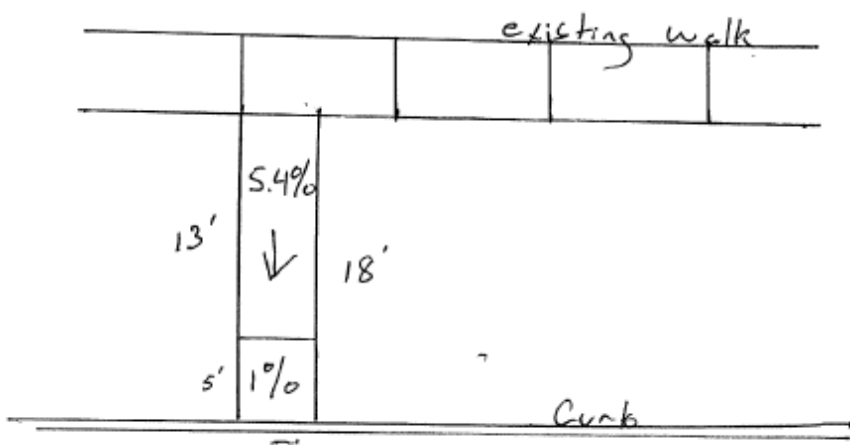



13

### BUS STOP INFORMATION

Date 9-27-18

Route 1,23,48 Inbound  Outbound  Trapeze ID 1721

GPS Latitude 42.72987 Longitude 084.46359 Capital Asset # \_\_\_\_\_

Nearest Crossroads WBD Gr. River past Hagedorn

Landmark-Corner / direction from Intersection 1375 M-43 / 1375 Grand River Av. East Lansing

Amenities at location

New Bus Stop / Shelter  Service Mount Base  In-Ground Base   
 Bench   
 Ash Trv   
 Trash Receptacle / Pole Mount  15 Gal \_\_\_\_\_ 30 Gal \_\_\_\_\_ 50 Gal \_\_\_\_\_  
 Install Information Sign / Type \_\_\_\_\_ Quantity \_\_\_\_\_ Size \_\_\_\_\_  
 Other / \_\_\_\_\_

Digital Photograph Taken Yes \_\_\_\_\_ No \_\_\_\_\_ Photo # \_\_\_\_\_

Shelter/bench on private property or in right a way \_\_\_\_\_

Shelter Make, Model and Size \_\_\_\_\_

Cement Size \_\_\_\_\_ Square Footage \_\_\_\_\_

Special Remarks roughly 60 sq' of concrete to remove and replace Pin to existing Concrete

Drawing Layout:

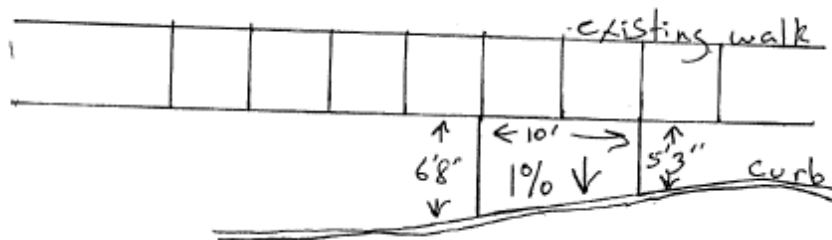

15

Google Maps 1375 M-43



14

### BUS STOP INFORMATION

Date 9-27-18

Route 20, 35, 38 Inbound  Outbound  Trapeze ID 6046

GPS Latitude 42.71386 Longitude 684.49390 Capital Asset # \_\_\_\_\_

Nearest Crossroads SBD Harrison before Crescent Rd. Swrth

Landmark-Corner / direction from Intersection S. Harrison Rd

#### Amenities at location

New Bus Stop / Shelter  Service Mount Base  In-Ground Base

Bench  
 Ash Trv

Trash Receptacle / Pole Mount  15 Gal  30 Gal  50 Gal

Install Information Sign / Type \_\_\_\_\_ Quantity \_\_\_\_\_ Size \_\_\_\_\_

Other / \_\_\_\_\_

Digital Photograph Taken Yes  No  Photo # \_\_\_\_\_

Shelter/bench on private property or in right a way \_\_\_\_\_

Shelter Make, Model and Size \_\_\_\_\_

Cement Size \_\_\_\_\_ Square Footage \_\_\_\_\_

Special Remarks 5x5 landing at 1%, 16' connector at 3.8%

#### Drawing Layout

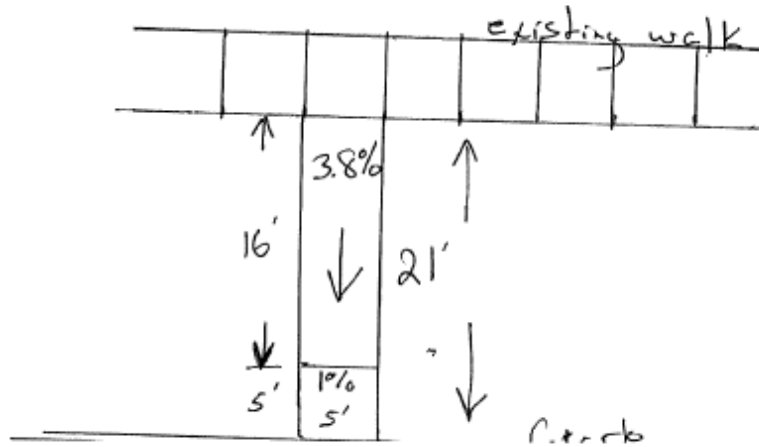

14

Google Maps S Harrison Rd



20

### BUS STOP INFORMATION

Date 4-6-21

Route 7 Inbound      Outbound X Trapeze ID 2442

GPS Latitude 42.72537 Longitude 084.53619 Capital Asset #     

Nearest Crossroads EBD Malcom X Past S. Pennsylvania

Landmark-Corner / direction from Intersection 1036 E. Main St. Lansing 48912

Amenities at location

New Bus Stop / Shelter  Service Mount Base  In-Ground Base

Bench  
 Ash Trv

Trash Receptacle / Pole Mount  15 Gal  30 Gal  50 Gal

Install Information Sign / Type  Quantity  Size

Other /     

Digital Photograph Taken Yes  No  Photo #     

Shelter/bench on private property or in right a way     

Shelter Make, Model and Size     

Cement Size 5' x 20.5' Square Footage 102.5 Sq'

Special Remarks remove one wooden bollard and  
pour a 5' x 21' Connector at 1%

Drawing Layout:

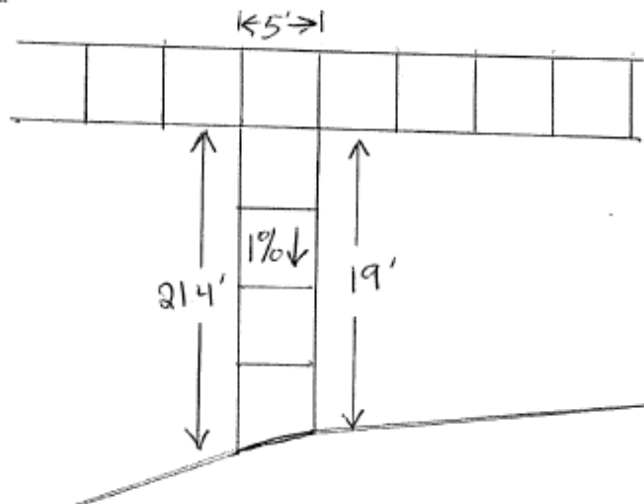



21

### BUS STOP INFORMATION

Date 4-7-21

Route 2 Inbound  Outbound  Trapeze ID 1763

GPS Latitude 42.69694 Longitude 084.58229 Capital Asset # \_\_\_\_\_

Nearest Crossroads SBD Pleasant Grove past Holmes

Landmark-Corner / direction from Intersection \_\_\_\_\_ 3420 Pleasant Grove Rd. Lensing  
48910

Amenities at location

New Bus Stop / Shelter  Service Mount Base  In-Ground Base

Bench

Ash Tray

Trash Receptacle / Pole Mount \_\_\_\_\_ 15 Gal \_\_\_\_\_ 30 Gal \_\_\_\_\_ 50 Gal \_\_\_\_\_

Install Information Sign / Type \_\_\_\_\_ Quantity \_\_\_\_\_ Size \_\_\_\_\_

Other / \_\_\_\_\_

Digital Photograph Taken Yes  No  Photo # \_\_\_\_\_

Shelter/bench on private property or in right a way \_\_\_\_\_

Shelter Make, Model and Size \_\_\_\_\_

Cement Size 3x5' + 4.8x10.2' Square Footage 64 Sq'

Special Remarks pour a 3'x5' connecting pad with a 10.2' x 4.8' bench pad behind existing walk with 1% fall towards the road way on the North side and match existing slope with the walk to the South

Drawing Layout

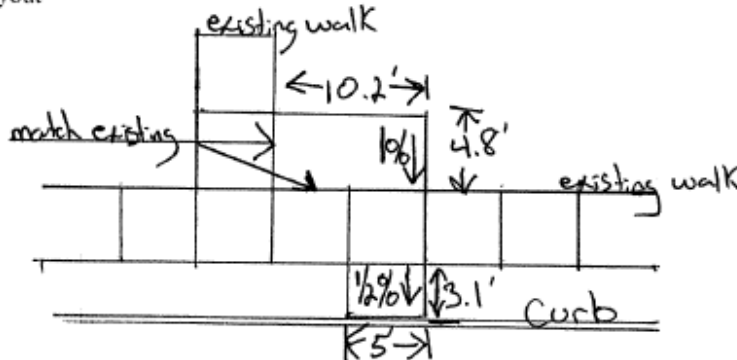

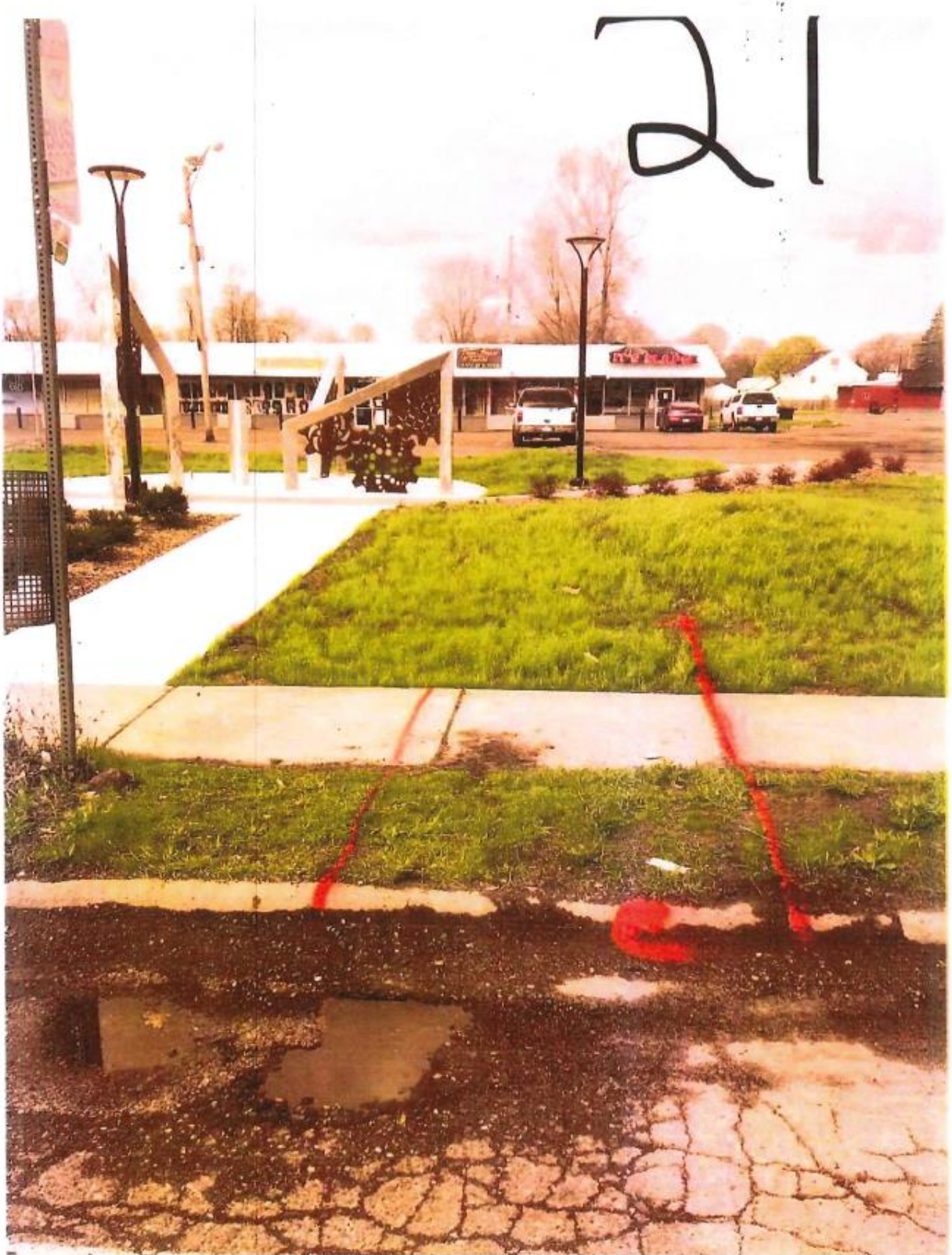

33

### BUS STOP INFORMATION

Date 4-7-21

Route 2 Inbound  Outbound  Trapeze ID 1796

GPS Latitude 42.69688 Longitude 084.58222 Capital Asset # \_\_\_\_\_

Nearest Crossroads NBD Pleasant Grove before Holme's

Landmark-Corner / direction from Intersection \_\_\_\_\_ 3427 Pleasant Grove Rd. Lansing 48916

Amenities at location

New Bus Stop / Shelter  Service Mount Base  In-Ground Base   
 Bench  
 Ash Try  
 Trash Receptacle / Pole Mount \_\_\_\_\_ 15 Gal \_\_\_\_\_ 30 Gal \_\_\_\_\_ 50 Gal \_\_\_\_\_  
 Install Information Sign / Type \_\_\_\_\_ Quantity \_\_\_\_\_ Size \_\_\_\_\_  
 Other / \_\_\_\_\_

Digital Photograph Taken Yes  No  Photo # \_\_\_\_\_

Shelter/bench on private property or in right a way \_\_\_\_\_

Shelter Make, Model and Size \_\_\_\_\_

Cement Size 5' x 17.4' Square Footage 87 Sq'

Special Remarks Demo 73 sq' of existing walk and replace with the addition of the 3' x 5' connector.

Drawing Layout

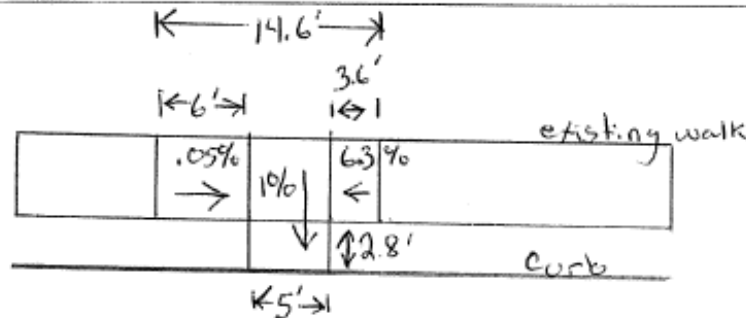

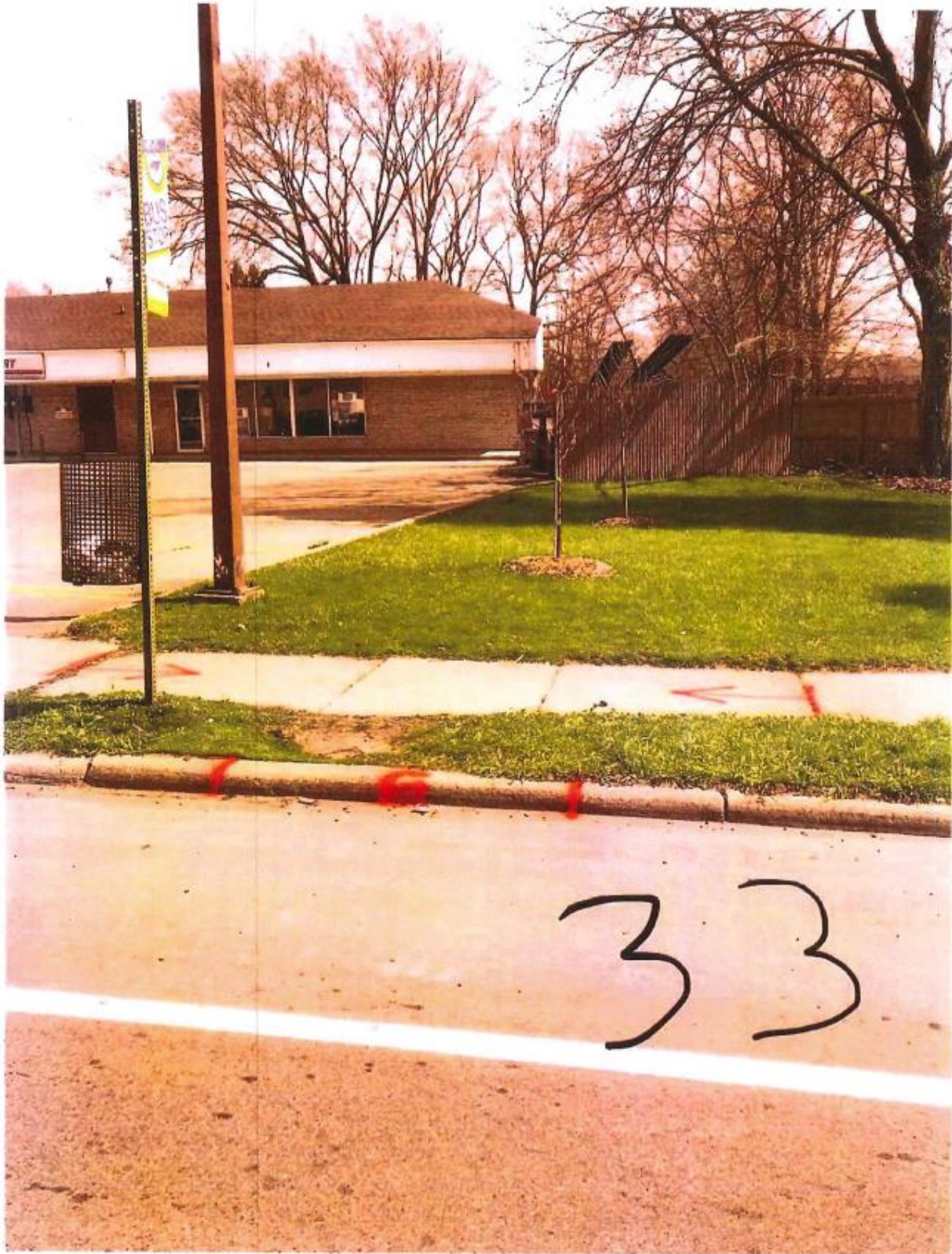

46

### BUS STOP INFORMATION

Date 7-2-21

Route 7 Inbound \_\_\_\_\_ Outbound X Trapeze ID \_\_\_\_\_

GPS Latitude \_\_\_\_\_ Longitude \_\_\_\_\_ Capital Asset # \_\_\_\_\_

Nearest Crossroads SBD Aurelius at Storage Sense

Landmark-Corner / direction from Intersection \_\_\_\_\_ 5600 N. Aurelius Rd. Lansing 48911

Amenities at location

New Bus Stop / Shelter \_\_\_\_\_ Service Mount Base \_\_\_\_\_ In-Ground Base   
 Bench \_\_\_\_\_  
 Ash Try \_\_\_\_\_  
 Trash Receptacle / Pole Mount \_\_\_\_\_ 15 Gal \_\_\_\_\_ 30 Gal \_\_\_\_\_ 50 Gal \_\_\_\_\_  
 Install Information Sign / Type \_\_\_\_\_ Quantity \_\_\_\_\_ Size \_\_\_\_\_  
 Other / \_\_\_\_\_

Digital Photograph Taken Yes  No \_\_\_\_\_ Photo # 46

Shelter/bench on private property or in right a way \_\_\_\_\_

Shelter Make, Model and Size \_\_\_\_\_

Cement Size 6' X 6' Square Footage 36 Sq'

Special Remarks 6' X 6' pad at 1% sloping away from the road

Drawing Layout

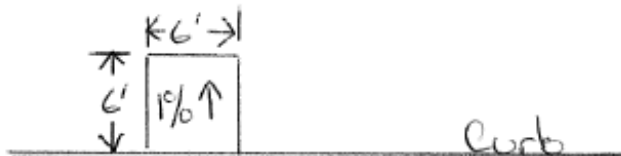

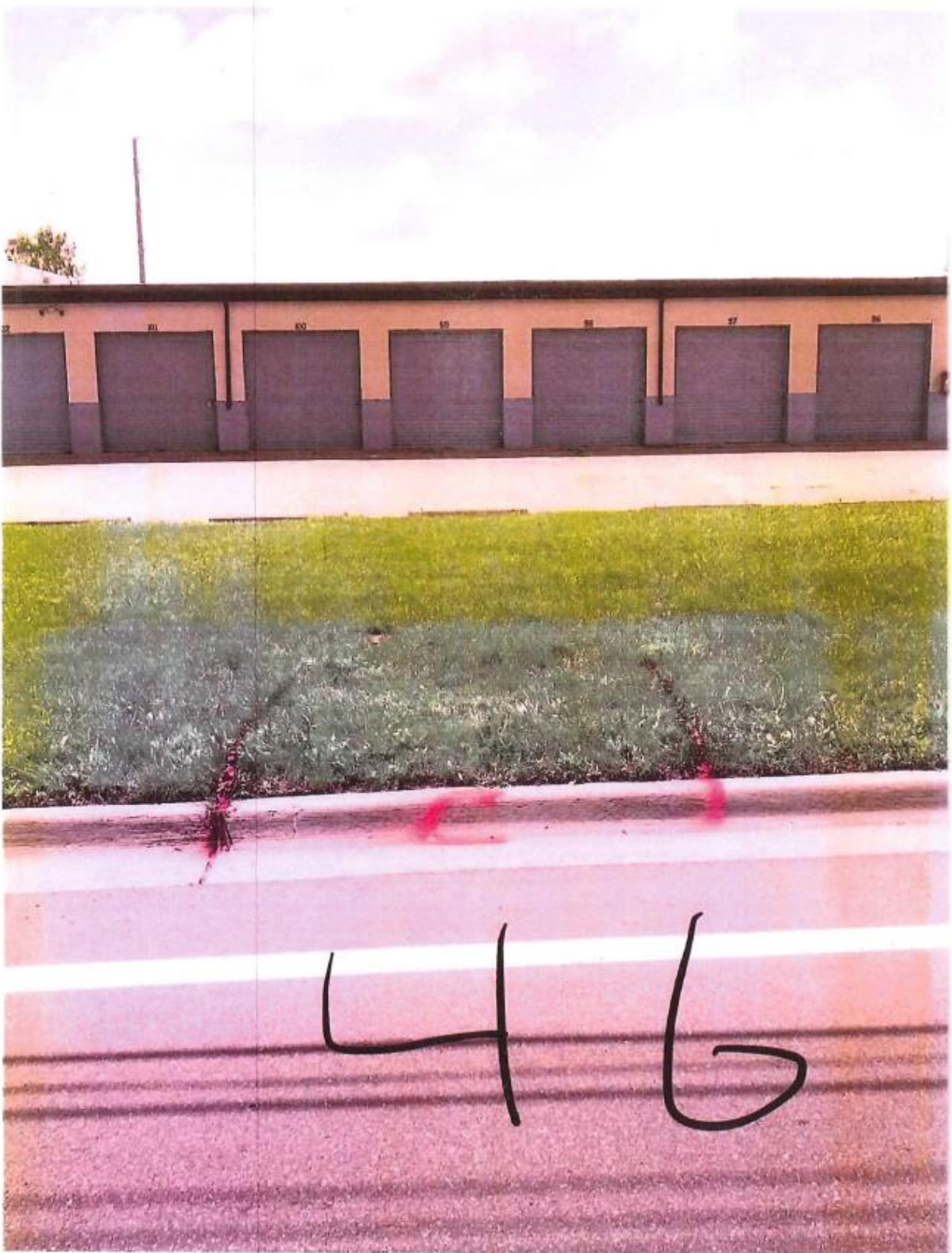

47

### BUS STOP INFORMATION

Date 7-2-21

Route 7 Inbound X Outbound \_\_\_\_\_ Trapeze ID \_\_\_\_\_

GPS Latitude 42.671770 Longitude 084.523434 Capital Asset # \_\_\_\_\_

Nearest Crossroads NBD Aurelius at Enterprise

Landmark-Corner / direction from Intersection Aprox 5901 N. Aurelius Rd Lausing 48911

Amenities at location

New Bus Stop / Shelter \_\_\_\_\_ Service Mount Base \_\_\_\_\_ In-Ground Base

Bench

Ash Try

Trash Receptacle / Pole Mount \_\_\_\_\_ 15 Gal \_\_\_\_\_ 30 Gal \_\_\_\_\_ 50 Gal \_\_\_\_\_

Install Information Sign / Type \_\_\_\_\_ Quantity \_\_\_\_\_ Size \_\_\_\_\_

Other / \_\_\_\_\_

Digital Photograph Taken Yes  No \_\_\_\_\_ Photo # 47

Shelter/bench on private property or in right a way \_\_\_\_\_

Shelter Make, Model and Size \_\_\_\_\_

Cement Size 5'x11', 5'x12' Square Footage 115 Sq'

Special Remarks 5'x5' landing pad at 1%, 5'x5' ramp at 4.3% and a 5'x12 Connector at 1/2%

Drawing Layout  $\leftarrow 12' \rightarrow$

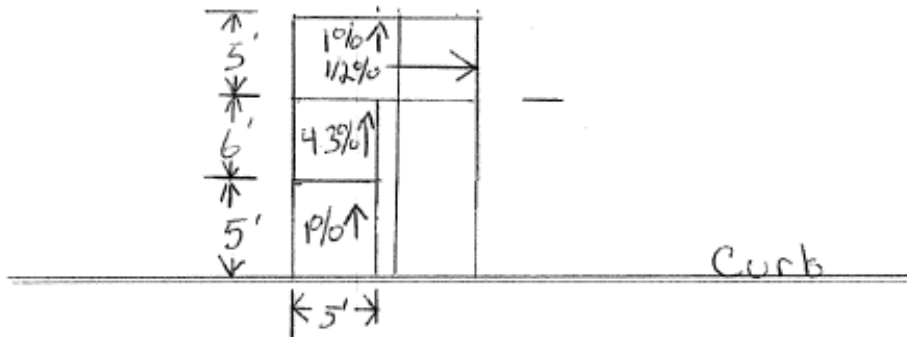

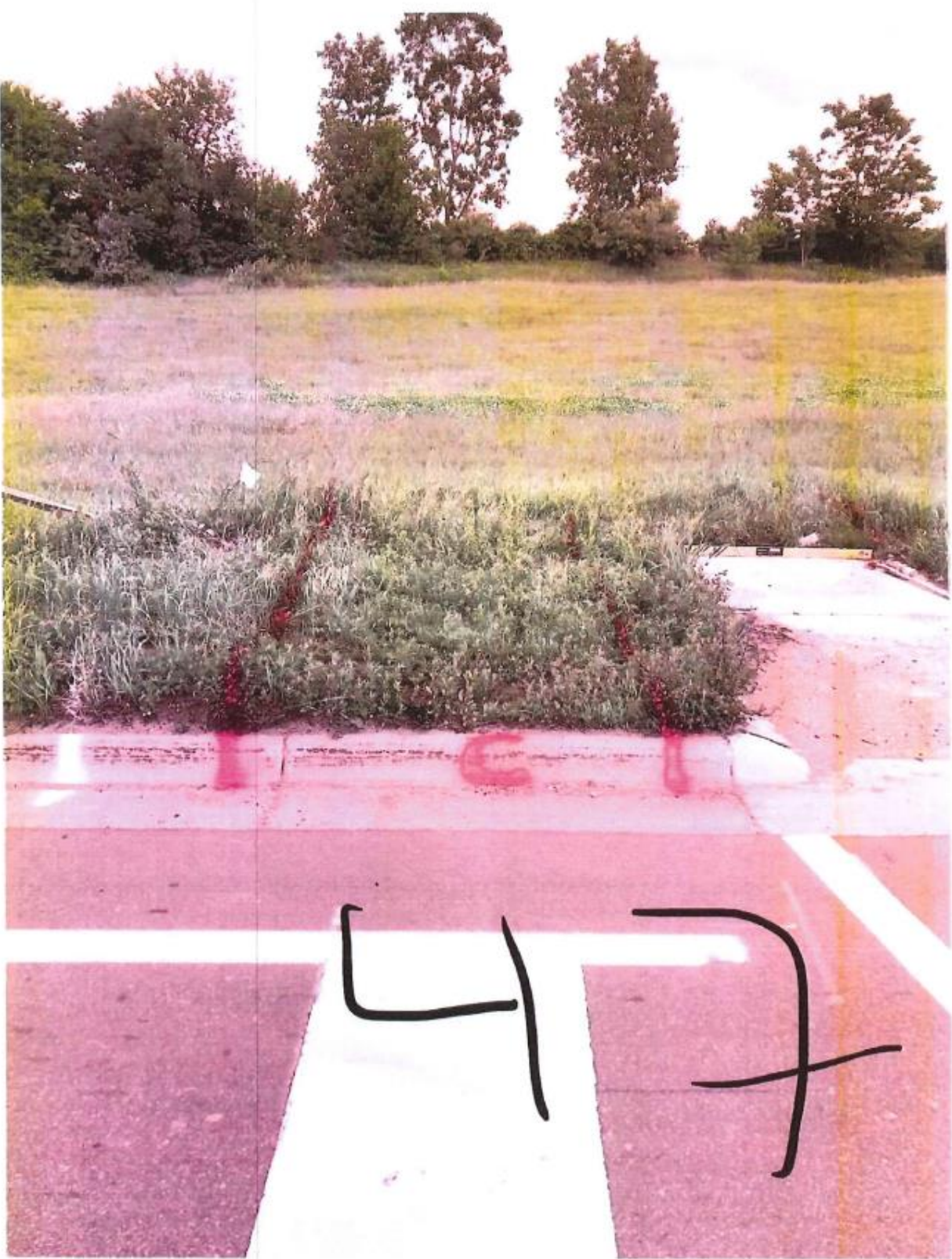



48

### BUS STOP INFORMATION

Date 7-2-21

Route 7 Inbound      Outbound X Trapeze ID     

GPS Latitude 42.671459 Longitude 84.523632 Capital Asset #     

Nearest Crossroads SBD Aurelius past Enterprise drive

Landmark-Corner / direction from Intersection Aprox S900 N Aurelius Rd Lansing 48911

Amenities at location

New Bus Stop / Shelter      Service Mount Base      In-Ground Base   
 Bench  
 Ash Tray  
 Trash Receptacle / Pole Mount      15 Gal      30 Gal      50 Gal       
 Install Information Sign / Type      Quantity      Size       
 Other /     

Digital Photograph Taken Yes  No      Photo # 48

Shelter/bench on private property or in right a way     

Shelter Make, Model and Size     

Cement Size 5' x 83' Square Footage 415 Sq'

Special Remarks 5'x5' landing at 1.5% with a 10' ramp at 7% towards curb, 43' of walk between ramps with only 1/2% cross slope and a 15' ramp at 6.1% to match up to the existing cross walk ramp

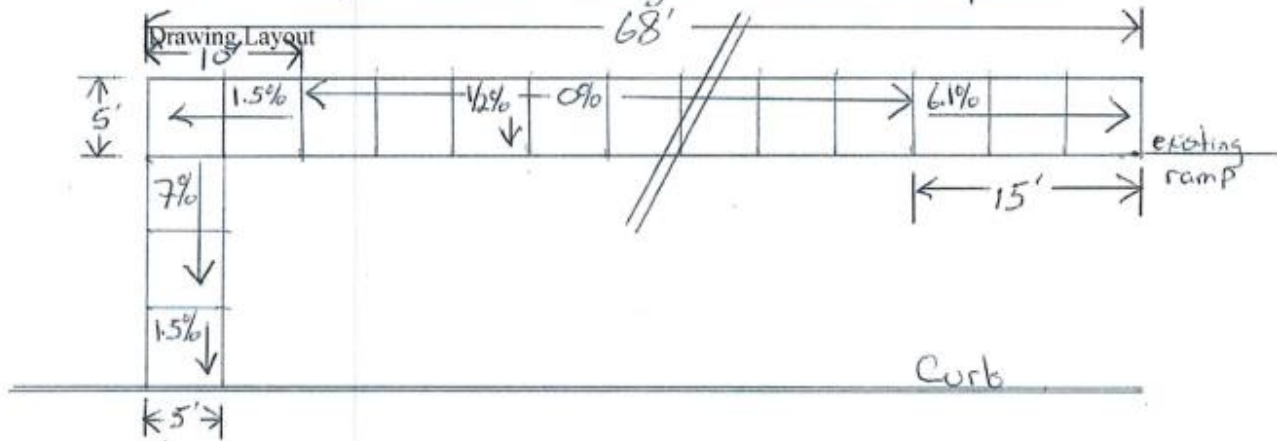

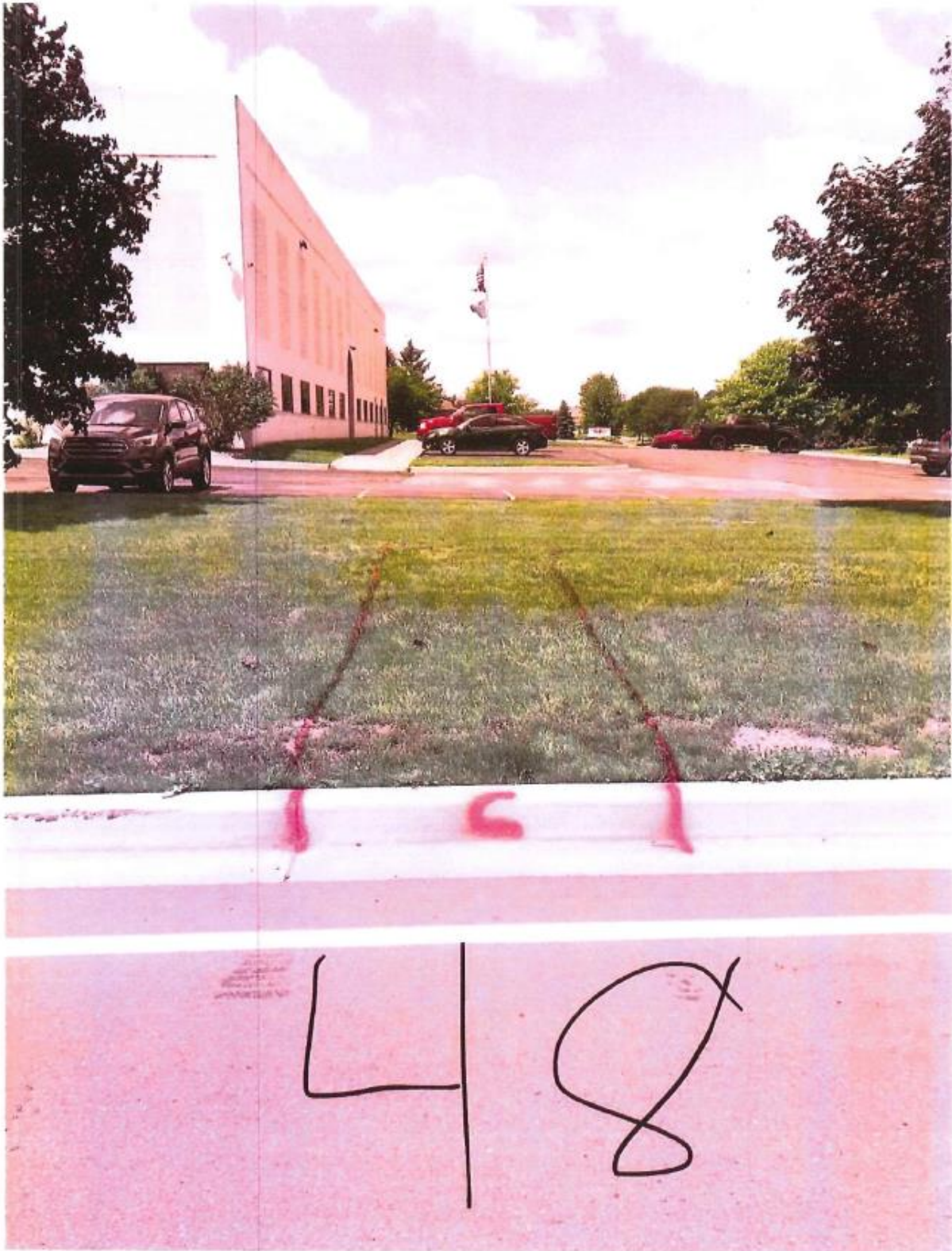

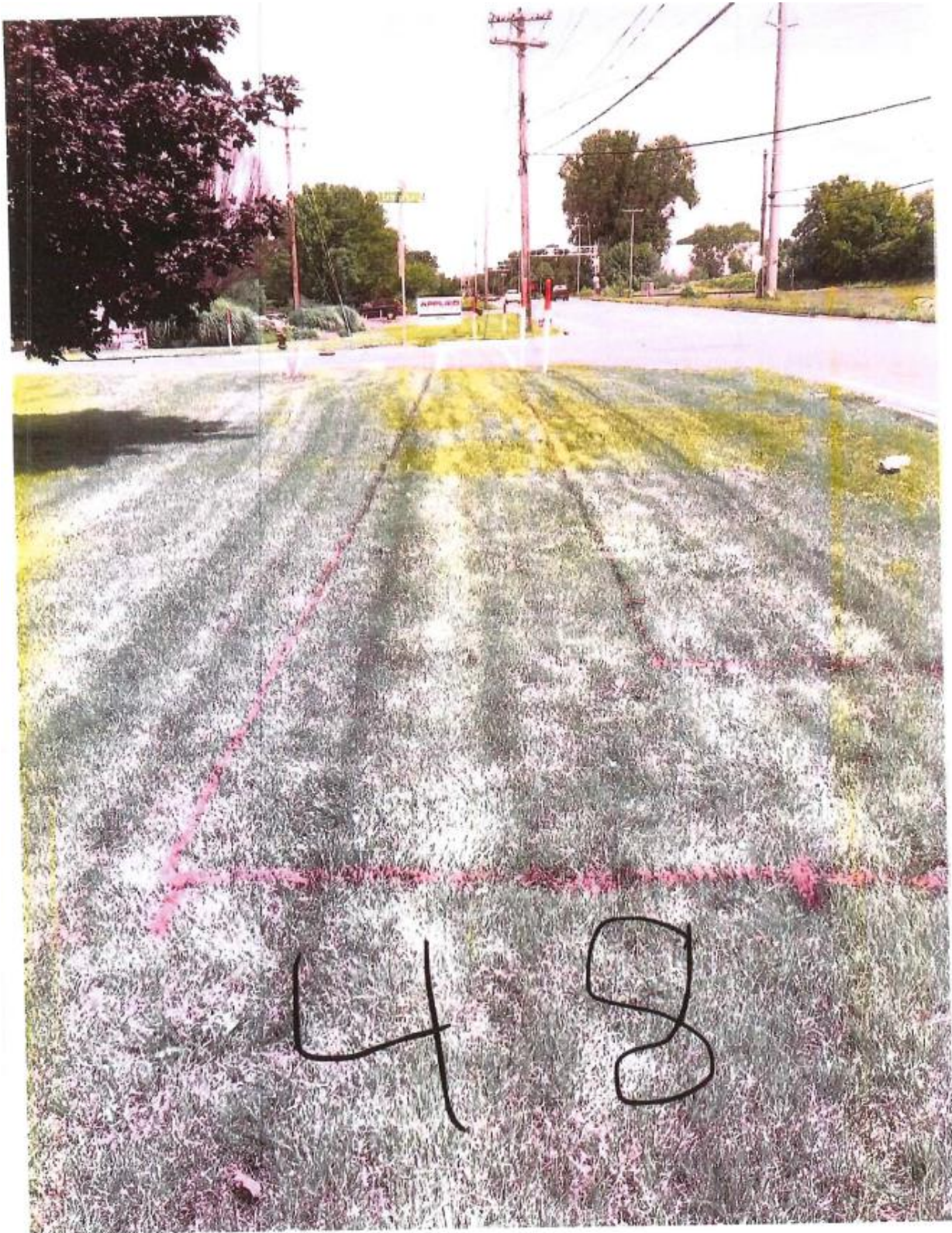

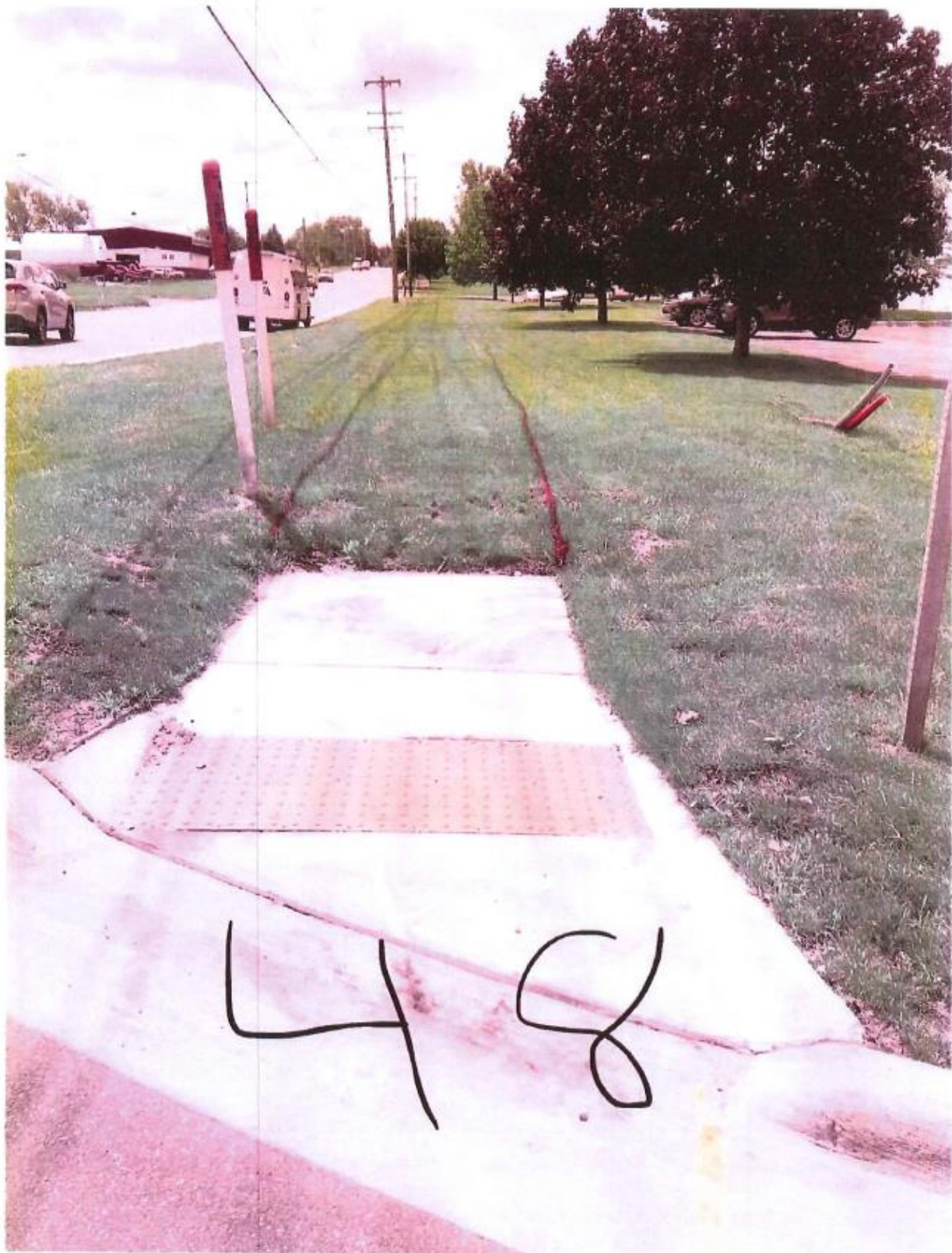

49

### BUS STOP INFORMATION

Date 7-2-21

Route 7 Inbound  Outbound \_\_\_\_\_ Trapeze ID \_\_\_\_\_

GPS Latitude 42.674332 Longitude 081.523446 Capital Asset # \_\_\_\_\_

Nearest Crossroads NBD Aurelius past Hope Sports Complex

Landmark-Corner / direction from Intersection \_\_\_\_\_ Approx 5727 N. Aurelius Rd Lansing 48911

Amenities at location

New Bus Stop / Shelter \_\_\_\_\_ Service Mount Base  In-Ground Base \_\_\_\_\_  
 Bench \_\_\_\_\_  
 Ash Try \_\_\_\_\_  
 Trash Receptacle / Pole Mount \_\_\_\_\_ 15 Gal \_\_\_\_\_ 30 Gal \_\_\_\_\_ 50 Gal \_\_\_\_\_  
 Install Information Sign / Type \_\_\_\_\_ Quantity \_\_\_\_\_ Size \_\_\_\_\_  
 Other / \_\_\_\_\_

Digital Photograph Taken Yes  No \_\_\_\_\_ Photo # 49

Shelter/bench on private property or in right a way \_\_\_\_\_

Shelter Make, Model and Size \_\_\_\_\_

Cement Size 6'x6' Square Footage 36 Sq'

Special Remarks 6'x6' pad at 1% towards the curb

Drawing Layout

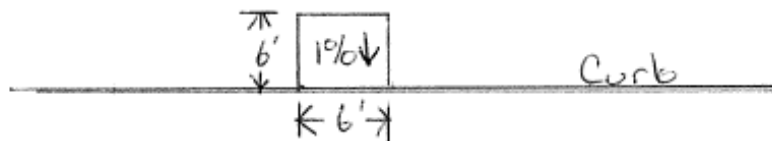

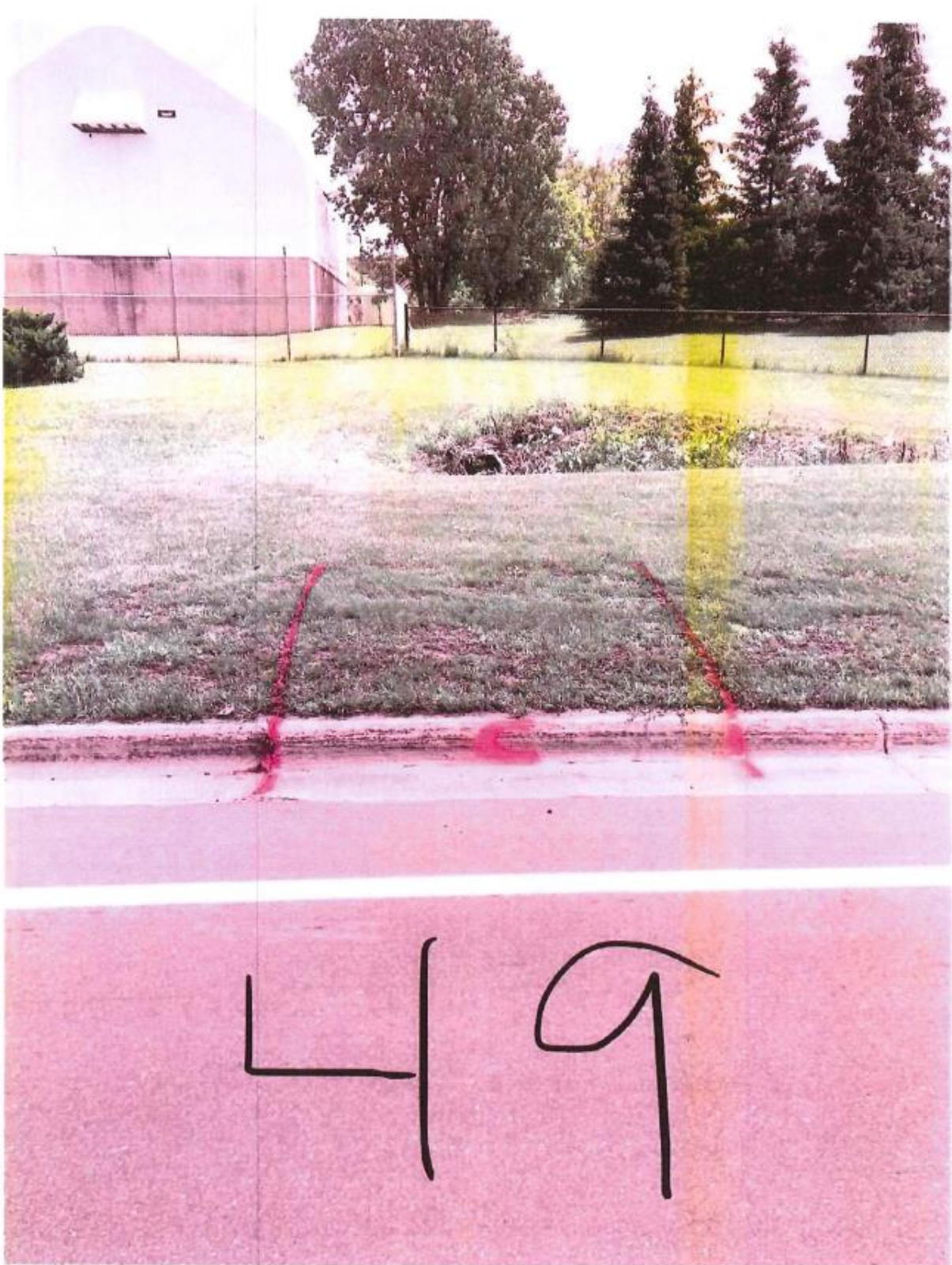

50

### BUS STOP INFORMATION

Date 7-6-21  
 Route 20 Inbound  Outbound  Trapeze ID \_\_\_\_\_  
 GPS Latitude 42.688201 Longitude -84.498870 Capital Asset # \_\_\_\_\_

Nearest Crossroads SBD Collins past Dunkle

Landmark-Corner / direction from Intersection Approx 4460 Collins Rd Lansing  
48924

Amenities at location

New Bus Stop / Shelter  Service Mount Base  In-Ground Base   
 Bench  
 Ash Try  
 Trash Receptacle / Pole Mount  15 Gal  30 Gal  50 Gal  
 Install Information Sign / Type \_\_\_\_\_ Quantity \_\_\_\_\_ Size \_\_\_\_\_  
 Other / \_\_\_\_\_

Digital Photograph Taken Yes  No  Photo # 50

Shelter/bench on private property or in right a way \_\_\_\_\_

Shelter Make, Model and Size \_\_\_\_\_

Cement Size 5'x12.1' Square Footage 60 Sq'

Special Remarks pour a 5'x12' connector at 1.9% towards  
the curb

Drawing Layout

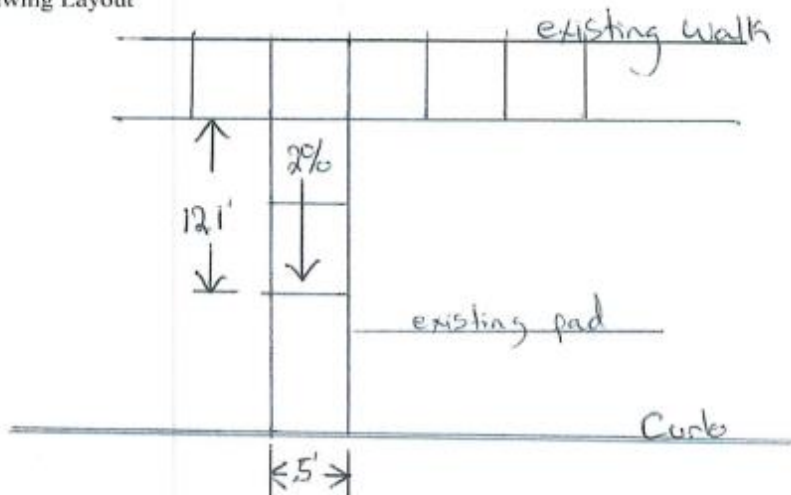



ATTACHMENT B

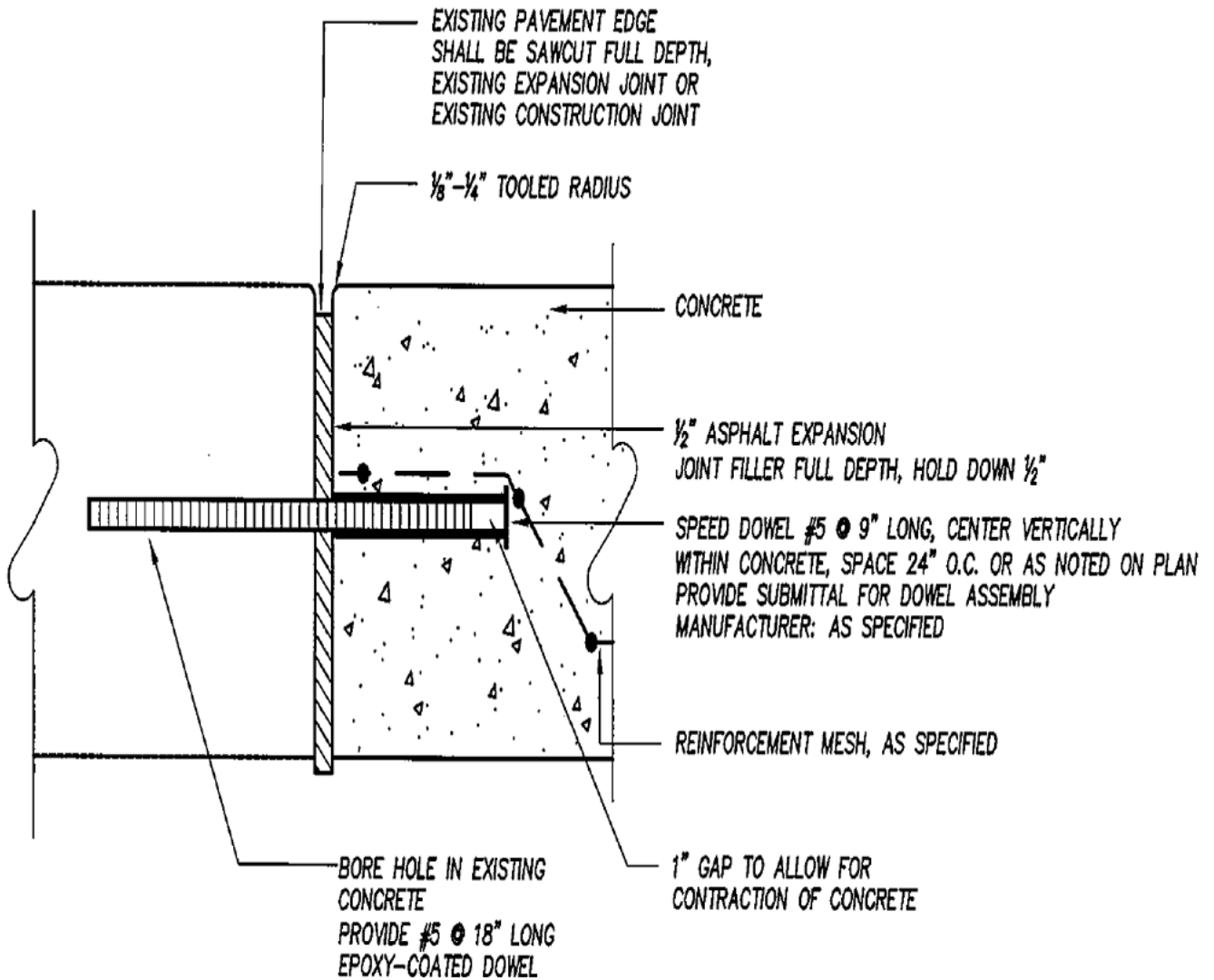

**X** EXPANSION JOINT AT EXISTING PAVEMENT  
**X-X** SCALE: 3"=1'-0"

**EXHIBIT B  
PRICING SCHEDULE**

Please provide pricing for the following:

<b>Location</b>	<b>Description</b>	<b>Price / Location Total</b>
SBD Cedar past American 6699 S. Cedar St. Lansing, MI 48911	Pad Cost & Fees: Labor & Materials	\$
	Trip Charges, Truck Charges, Other Charges, Permits	\$
WBD Kalamazoo past Pine 600 W. Kalamazoo St. Lansing, MI 48933	Pad Cost & Fees: Labor & Materials	\$
	Trip Charges, Truck Charges, Other Charges, Permits	\$
EBD Grand River past Marsh 1931 Grand River Ave. Meridian Township, MI 48864	Pad Cost & Fees: Labor & Materials	\$
	Trip Charges, Truck Charges, Other Charges, Permits	\$
WBD Grand River past Marsh 2011 Grand River Ave. Okemos, MI 48864	Pad Cost & Fees: Labor & Materials	\$
	Trip Charges, Truck Charges, Other Charges, Permits	\$
WBD Grand River past Hagadorn 1375 Grand River Ave. East Lansing, MI 48823	Pad Cost & Fees: Labor & Materials	\$
	Trip Charges, Truck Charges, Other Charges, Permits	\$
SBD Harrison before Crescent S. Harrison Rd. East Lansing, MI 48823	Pad Cost & Fees: Labor & Materials	\$
	Trip Charges, Truck Charges, Other Charges, Permits	\$
EBD Malcolm X past Pennsylvania 1036 E. Main St. Lansing, MI 48912	Pad Cost & Fees: Labor & Materials	\$
	Trip Charges, Truck Charges, Other Charges, Permits	\$
SBD Pleasant Grove past Holmes 3420 Pleasant Grove Rd. Lansing, MI 48910	Pad Cost & Fees: Labor & Materials	\$
	Trip Charges, Truck Charges, Other Charges, Permits	\$
NBD Pleasant Grove before Holmes 3427 Pleasant Grove Rd. Lansing, MI 48910	Pad Cost & Fees: Labor & Materials	\$
	Trip Charges, Truck Charges, Other Charges, Permits	\$
SBD Aurelius at Storage Sense 5600 N. Aurelius Rd. Lansing, MI 48911	Pad Cost & Fees: Labor & Materials	\$
	Trip Charges, Truck Charges, Other Charges, Permits	\$
NBD Aurelius at Enterprise 5901 N. Aurelius Rd. Lansing, MI 48911	Pad Cost & Fees: Labor & Materials	\$
	Trip Charges, Truck Charges, Other Charges, Permits	\$
SBD Aurelius past Enterprise 5900 N. Aurelius Rd. Lansing, MI 48911	Pad Cost & Fees: Labor & Materials	\$
	Trip Charges, Truck Charges, Other Charges, Permits	\$
NBD Aurelius past Sports Complex 5727 N. Aurelius Rd. Lansing, MI 48911	Pad Cost & Fees: Labor & Materials	\$
	Trip Charges, Truck Charges, Other Charges, Permits	\$
SBD Collins past Dunckel 4460 Collins Rd. Lansing, MI 48924	Pad Cost & Fees: Labor & Materials	\$
	Trip Charges, Truck Charges, Other Charges, Permits	\$
<b>GRAND TOTAL</b>		<b>\$</b>

**CATA requires the work to be completed on or before, Sunday, November 14, 2021 @ 5:00 P.M. Eastern Time.**

Bidder: \_\_\_\_\_

Signature: \_\_\_\_\_

Printed Name: \_\_\_\_\_

Title: \_\_\_\_\_

Date: \_\_\_\_\_

**THIS FORM MUST BE COMPLETED AND RETURNED WITH YOUR OFFER**

**EXHIBIT C  
SUBMITTAL CHECKLIST**

Deadline: September 30, 2021 at 2:00 P.M. Eastern Time  
(A quote will be automatically rejected if it is received after the stated deadline.)

**All forms/certifications below MUST be completed and included when you submit you quote package.**

**Failure to submit the requested documents could result in determining the submission as non-responsive and rejected.**

- Signed and completed Pricing Schedule Form (Page 36-37)
- Signed and completed Submittal Checklist Form (Page 38)
- Signed and completed Iran Economic Sanctions Act Certificate (Page 39)
- Signed and completed Offer and Guarantees (Page 40)
- Signed Certification of Primary Contractor Regarding Debarment & Suspension (Page 41)
- Signed Certification of Lower-Tier Participants (Sub-Contractors) Regarding Debarment & Suspension (if applicable) (Page 42)
- Signed and completed DBE Participation Form (Page 43-44)
- 5% Bid Bond
- Signed and completed Amendment(s) (as issued)

**Please Note:** This bid package and any amendments are available at [www.cata.org](http://www.cata.org). Please continue checking the website for any updates or amendments

**SUBMITTED QUOTE CONTAINS ALL COMPLETED FORMS/CERTIFICATIONS AS LISTED ABOVE**

Bidder: \_\_\_\_\_

Signature: \_\_\_\_\_

Printed Name: \_\_\_\_\_

Title: \_\_\_\_\_

Date: \_\_\_\_\_

**THIS FORM MUST BE COMPLETED AND RETURNED WITH YOUR OFFER**

**EXHIBIT D**  
**IRAN ECONOMIC SANCTIONS ACT CERTIFICATE**

---

In accordance with the Iran Economic Sanctions Act, Michigan 2012 PA 517, effective April 1, 2013, (MCL 129.311, *et seq.*), the undersigned certifies in support of its bid or proposal that it is not an Iran linked business as such is defined in the Act.

Bidder: \_\_\_\_\_

Signature: \_\_\_\_\_

Printed Name: \_\_\_\_\_

Title: \_\_\_\_\_

Date: \_\_\_\_\_

**THIS FORM MUST BE COMPLETED AND RETURNED WITH YOUR OFFER**

**EXHIBIT E**  
**OFFER and GUARANTEES**

By execution below, the Bidder hereby offers to furnish the items as described herein. The Bidder also certifies that it can and will provide and make available, at a minimum, the items set forth in this solicitation.

<b>FIRM'S NAME AND ADDRESS</b>		<b>PAYMENT REMITTANCE ADDRESS</b>	
<b>Name:</b>		<b>Name:</b>	
<b>Address:</b>		<b>Address:</b>	
<b>P.O. Box or Suite No.</b>		<b>P.O. Box or Suite No.</b>	
<b>City</b>		<b>City</b>	
<b>State</b>	<b>Zip</b>	<b>State</b>	<b>Zip</b>
<b>Contact Person:</b>			
<b>Telephone No.</b>	<b>Fax No.</b>	<b>E-Mail Address:</b>	
<b>FEDERAL EMPLOYER I.D. NUMBER:</b>		<b>SOCIAL SECURITY NUMBER:</b> (If Federal I.D. is not applicable)	
<b>Payment Terms:</b>		<b>Age of Firm:</b>	
<b>Disadvantaged Business Enterprise:</b> ( ) Yes      ( ) No If yes, attach the certificate from the certifying agency.			
<b>Minority Business Category:</b> ( ) Female ( ) Black ( ) Hispanic ( ) Asian American ( ) Indian/Alaskan Native ( ) Other ( ) Not Applicable			
<b>Annual Gross Receipts:</b> ( ) less than \$500,000 ( ) \$500,000 to \$1 million ( ) \$1 million to \$5 million ( ) greater than \$5 million			
<b>Contractor's License Type:</b>			
<b>Contractor's License Number:</b>			
<b>License Expiration Date:</b>			
<b>NAME OF BIDDER (Type or Print)</b>		<b>TITLE OF BIDDER</b>	
<b>Signature of Contractor's Authorized Official</b>		<b>(Date Signed)</b>	

**THIS FORM MUST BE COMPLETED AND RETURNED WITH YOUR OFFER**

**EXHIBIT F**

**CERTIFICATION OF PRIMARY CONTRACTOR REGARDING DEBARMENT, SUSPENSION AND OTHER RESPONSIBILITY MATTERS**

The Primary Contractor, \_\_\_\_\_, certifies to the best of its knowledge and belief, that it and its principals:

1. Are not presently debarred, suspended, proposed for debarment, declared ineligible, or voluntarily excluded from covered transactions by any Federal department or agency;
2. Have not within a three (3) year period preceding this proposal been convicted of or had a civil judgment rendered against them for commission of fraud or a criminal offense in connection with obtaining, attempting to obtain, or performing a public (Federal, State or Local) transaction or contract under a public transaction; violation of Federal or State antitrust statutes or commission of embezzlement, theft, forgery, bribery, falsification or destruction of records, making false statements, or receiving stolen property;
3. Are not presently indicted for or otherwise criminally or civilly charged by a governmental entity (Federal, State, or Local) with commission of any of the offense enumerated in paragraph (2) of this certification; and
4. Have not within a three (3) year period preceding this application/proposal had one (1) or more public transactions (Federal, State, or Local) terminated for cause or default.

If the above named Primary Contractor is unable to certify to any of the statements in this certification, the Primary Contractor shall attach an explanation to this certification.

The Primary Contractor, \_\_\_\_\_, certifies or affirms the truthfulness and accuracy of the contents of the statements submitted on or with this certification and understands that the provision of 31 U.S.C. Section 3801 et seq. are applicable thereto.

Bidder: \_\_\_\_\_

Signature: \_\_\_\_\_

Printed Name: \_\_\_\_\_

Title: \_\_\_\_\_

Date: \_\_\_\_\_

**THIS FORM MUST BE COMPLETED AND RETURNED WITH YOUR OFFER**

**EXHIBIT G**

**CERTIFICATION OF LOWER-TIER PARTICIPANTS (SUB-CONTRACTORS) REGARDING DEBARMENT, SUSPENSION AND OTHER RESPONSIBILITY MATTERS**

**Debarment and Suspension Certification (Lower-Tier Covered Transaction)**

This form is to be submitted by each Subcontractor receiving an amount exceeding \$25,000.

The prospective lower-tier participant (Proposer) certifies, by submission of this Proposal, that neither it nor its "principals" as defined at 49 CFR § 29.105(p) is presently debarred, suspended, proposed for debarment, declared ineligible, or voluntarily excluded from participation in this transaction by any federal department or agency.

If the prospective Proposer is unable to certify to the statement above, it shall attach an explanation, and indicate that it has done so by placing an "X" in the following space: \_\_\_\_\_

**THE PROPOSER, \_\_\_\_\_, CERTIFIES OR AFFIRMS THE TRUTHFULNESS AND ACCURACY OF EACH STATEMENT OF ITS CERTIFICATION AND EXPLANATION, IF ANY. IN ADDITION, THE PROPOSER UNDERSTANDS AND AGREES THAT THE PROVISIONS OF 31 USC §§ 3801 ET SEQ. APPLY TO THIS CERTIFICATION AND EXPLANATION, IF ANY.**

**Name and title of the Proposer's authorized official:**

\_\_\_\_\_  
Authorized signature

\_\_\_\_\_  
Date

**THIS FORM MUST BE COMPLETED AND RETURNED WITH YOUR OFFER**

**EXHIBIT H  
DBE PARTICIPATION FORM**

**DBE PARTICIPATION FORM**

INSTRUCTIONS FOR DBE FORM COMPLETION IS ON THE FOLLOWING PAGE

BLANK forms are NOT acceptable. If DBE subcontractor opportunities are available please fill out sections 1 thru 5. If no subcontractor opportunities are available fill out section 6. **SIGNATURES ARE REQUIRED.** Separate forms are required for each DBE subcontractor. This form may be duplicated as necessary.

1. **DBE Firm Name:** \_\_\_\_\_

**Address:** \_\_\_\_\_  
\_\_\_\_\_

2. **Dollar amount awarded:** \_\_\_\_\_

3. **Description of work to be performed:** \_\_\_\_\_  
\_\_\_\_\_  
\_\_\_\_\_

**4. CONTRACTOR'S COMMITMENT TO USE DBE FIRM**

\_\_\_\_\_, is committed to utilize the DBE contractor to utilize the above named  
(Name of Contractor) DBE subcontractor/supplier in the manner and amount described on this form.

Dated \_\_\_\_\_ (Authorized Signature)

**5. DBE'S COMMITMENT TO PARTICIPATE**

\_\_\_\_\_, as a DBE firm, is committed to perform the work as described  
(Name of subcontractor/supplier) above for the amount specified.

Dated \_\_\_\_\_ (Authorized Signature)

**6. NO SUBCONTRACT OPPORTUNITIES AVAILABLE**

\_\_\_\_\_, has no subcontractor opportunities available for work to be performed.  
(Name of subcontractor/supplier)

Dated \_\_\_\_\_ (Authorized Signature)

**THIS FORM MUST BE COMPLETED AND RETURNED WITH YOUR OFFER**

**DBE PARTICIPATION FORM - INSTRUCTIONS**

1. **DBE Firm Name:** \_\_\_\_\_  
**Address:** \_\_\_\_\_  
 \_\_\_\_\_  
 \_\_\_\_\_

Sub-contractor name and address

2. **Dollar amount awarded:** \_\_\_\_\_

Amount awarded to Sub contractor

3. **Description of work to be performed:** \_\_\_\_\_  
 \_\_\_\_\_  
 \_\_\_\_\_

Work description

4. **CONTRACTOR'S COMMITMENT TO USE DBE FIRM**

Prime contractor fills out

\_\_\_\_\_, is committed to utilize the DBE contractor to utilize the above named  
 (Name of Contractor) DBE subcontractor/supplier in the manner and amount described on this  
 form.

Dated \_\_\_\_\_ (Authorized Signature)

5. **DBE'S COMMITMENT TO PARTICIPATE**

Sub-contractor fills out

\_\_\_\_\_, as a DBE firm, is committed to perform the work as described  
 (Name of subcontractor/supplier) above for the amount specified.

Dated \_\_\_\_\_ (Authorized Signature)

6. **NO SUBCONTRACT OPPORTUNITIES AVAILABLE.**

Prime contractor fills out

\_\_\_\_\_, has no subcontractor opportunities available for work to be performed  
 (Name of subcontractor/supplier)

Dated \_\_\_\_\_ (Authorized Signature)

---

**EXHIBIT I**  
**TERMS and CONDITIONS**

---

**CAPITAL AREA TRANSPORTATION AUTHORITY**  
**STANDARD TERMS AND CONDITIONS OF PROCUREMENT****A. THE FOLLOWING TERMS AND CONDITIONS WILL BE A PART OF THE CONTRACT AWARDED.**

1. **CHANGES.** CATA, at any time, by a written order, and without notice to the sureties, may make changes within the general scope of this contract, in (a) drawings, designs or specifications where the supplies to be furnished are specifically manufactured for CATA in accordance therewith; (b) method of shipment or packing; and (c) place of delivery. If any such change causes an increase or decrease in the cost of, or the time required for performance of this contract, whether changed or not changed by such order, an equitable adjustment shall be made by written modification of the contract. Any claim by the Contractor for adjustment under this clause must be asserted within thirty (30) days from the date of receipt by the Contractor of the notification of change; provided that CATA, if it decides that the facts justify the action, may receive and act upon any such claim if asserted prior to dispute concerning a question of fact within the meaning of the clause of this contract entitled "Disputes." However, nothing in this clause shall excuse the Contractor from proceeding with the contract as changed.
2. **TERMINATION FOR DEFAULT.** CATA, by written notice, may terminate the contract awarded on the basis of this proposal, in whole or in part, for failure of the Contractor to perform any of the provisions hereof. In such event, the Contractor shall be liable for damages, including the excess cost of reprocurring similar supplies or services, provided, that if (a) it is determined for any reason that the contract was not in default or, (b) the Contractor's failure to perform is without his control, fault or negligence, the termination shall be deemed to be a termination for convenience under the following Paragraph 3.
3. **TERMINATION FOR CONVENIENCE.** CATA, by written notice, may terminate the contract, awarded on the basis of this proposal, in whole or in part, when it determines it is in the best interest of CATA. If this contract is for supplies and is so terminated, the Contractor shall be compensated in accordance with its auditable cost incurred at the time of notification of termination. To the extent that the contract is for services and is so terminated, CATA shall be liable only for payment in accordance with the payment provisions of the contract for services rendered to the effective date of termination.
4. **ADDITIONAL INFORMATION.** The Contractor shall promptly furnish any additional information requested by CATA relative to the equipment it proposes.
5. **SUPPLIER RESPONSIBILITY.** No advantage shall be taken by the Contractor or its Subcontractor in the omission of any part or detail which goes to make the equipment complete and operable for use by CATA. In case of any variance, this specification shall overrule Contractor or Subcontractor specifications. The Contractor shall assume responsibility for all materials used whether the same is manufactured by the Contractor or purchased ready made from a source outside Contractor's company. In the case of the replacement of a Subcontractor, the Contractor must, within five (5) working days, notify CATA in writing of the replacement and provide name, address, telephone number, and the type of service.
6. **DELIVERY.** Service and/or equipment will be delivered to Capital Area Transportation Authority, 4615 Tranter Street, Lansing, Michigan 48910. The Authority will assume custody of all property at one of its other locations, if so directed, in writing by CATA. Invoices shall be furnished with the delivery of each item. CATA reserves the right to inspect all deliveries or services before acceptance.
7. **BREACH OF CONTRACT.** If the Contractor shall fail, refuse or neglect to comply with the terms of these contract conditions, such failure shall be deemed a total breach of contract, Contractor shall be subject to all legal remedies that CATA may have and CATA may recover, in addition to any damages, its reasonable costs and attorneys' fees resulting from Contractor's breach, plus costs relating to failure to comply.
8. **DISPUTES (AFTER BID AWARD).** Except as otherwise provided in the contract, any dispute concerning a question of fact arising under the contract which is not disposed of by agreement between CATA and Contractor shall be decided by CATA's Program Manager in writing, with a copy mailed or otherwise furnished to the Contractor. The decision of CATA shall be final and conclusive unless within ten (10) days from the date of receipt of such copy, the Contractor mails or otherwise furnishes to CATA a written appeal addressed to CATA's Chief Executive Officer for the determination of such appeal, which shall be final and conclusive, unless determined by a court of competent jurisdiction to have been fraudulent or capricious, or arbitrary, or so grossly erroneous as necessarily to imply bad faith, or not supported by substantial evidence. In connection with any appeal proceeding under this clause, the Contractor shall be afforded an opportunity to be heard and to offer evidence in support of its appeal. Pending a final decision of the dispute, the Contractor shall proceed diligently with the performance of the contract and in accordance with CATA's decision.

9. DELIVERY EXTENSION AND DELAYS. CATA reserves the right to extend, postpone or reschedule delivery in case the delivery of service equipment, under this contract, shall be necessarily delayed because of strike, injunction, civil disturbance, government controls, or by reason of any cause or circumstance beyond the control of the Contractor, as detailed in writing by the Contractor, the time of completion or a delivery shall be extended by a number of days to be determined in each instance by CATA.
10. INSTALLATION. If specified, the Contractor shall install and place in operation, subject to approval by CATA, the equipment at the Contractor's expense within thirty (30) days from issuance of a notice to install issued by CATA.
11. INSTALLATION EXTENSION AND DELAYS. CATA reserves the right to extend, postpone, or reschedule installation in case the installation of equipment under this contract shall be necessarily delayed because of strike, injunction, civil disturbance, government controls, or by reason or cause or circumstances beyond the control of the Contractor. The time of completion or installation shall be extended by a number of days to be determined in each instance by CATA.
12. ASSEMBLY. If required, the Contractor shall assemble the equipment at its expense prior to installation.
13. ACCESSORIES. The Contractor shall furnish, without additional cost, all accessories required to permit CATA to operate any equipment being provided.
14. TRAINING. The Contractor, without additional cost, shall properly train CATA personnel in the operation and maintenance of the equipment provided.
15. SERVICE MANUAL AND WIRING SCHEMATIC. If specified, the Contractor will provide at least one copy of a service manual and at least one copy of a wiring schematic for individual components and other schematics and drawings.
16. WARRANTY. The Contractor shall describe its policy or warranty(s) both on workmanship and material as applying to the equipment, along with the method or adjustment, and shall be further subject to warranty requirements of CATA as set forth in the following Paragraph 17.
17. CATA WARRANTY. The Contractor agrees that the supplies or services furnished under this contract shall be covered by the most favorable warranties the Contractor gives any customer for such equipment and that the rights and remedies provided herein are in addition to and do not limit any rights afforded to CATA by any other clause of this contract. The Contractor shall state the warranty and supply with its bid.
18. INSURANCE. The Contractor shall place and maintain with responsible insurance carriers the following insurance. The Contractor shall deliver to CATA, upon request, certificates of insurance which shall provide thirty (30) days' written notice to be given to CATA in the event of cancellation. Contractor shall require all Subcontractors to maintain adequate insurance coverage.
- (a) Workers' Compensation and Employer's Liability Insurance.
- (1) Workers' Compensation in compliance with the applicable state and federal laws.
- (2) Employer's Liability. Limit \$1,000,000.
- (b) Commercial General Liability Insurance, including Professional Liability, Blanket contractual, XCU Hazards, Broad Form Property Damage, Completed Operations, and Independent Contractor's Liability, all applicable to Personal Injury, Bodily Injury and Property Damage to a combined single limit of \$1,000,000 each occurrence/claim, subject to a \$2,000,000 annual aggregate for Professional Liability, Completed Operations and Personal Injury other than Bodily Injury.
- (c) Automobile Liability Insurance, including owned, hired and non-owned automobiles, Bodily Injury and Property Damage, to a combined single limit of \$1,000,000 each occurrence.
19. INDEMNIFICATION. In addition to the protection afforded by any policy of insurance, the Contractor agrees to indemnify and save harmless CATA, the Michigan Department of Transportation ("MDOT"), the Federal Transit Administration ("FTA"), and all officers, agents, and employees thereof:
- (a) From any and all claims by persons, firms, or corporations for labor, materials, supplies, or services provided to the Contractor in connection with the Contractor's performance of the contract; and
- (b) From any and all claims for injuries to or death of any and all persons, for loss of or damage to property, for environmental damage, degradation and response, and cleanup costs, and for attorney fees and related costs arising out of, under, or by reason of the Contractor's negligent performance of the contract.

CATA will not be subject to any obligations or liabilities by Subcontractors of the Contractor or their Subcontractors or any other person not a party to this contract without its specific consent and notwithstanding its concurrence in or approval of the award of any contract or subcontract or the solicitation thereof.

20. **ACCEPTANCE OF MATERIAL - NO RELEASE.** Unless CATA otherwise agrees in writing, acceptance of any portion of the material prior to final acceptance shall not release the Contractor from liability for faulty workmanship or materials or for failure to fully comply with all of the terms of this contract. CATA reserves the right and shall be at liberty to inspect all materials and workmanship at any time during the manufacturing process, and shall have the right to reject all materials and workmanship which do not conform with the contract requirements and specifications; provided, however, that CATA is under no duty to make such inspection and no inspection so made shall relieve Contractor from any obligation to furnish materials and workmanship in accordance with the contract requirements and specifications.
21. **FINAL ACCEPTANCE.** Upon final acceptance by CATA of all work to be performed by the Contractor, CATA will so notify the Contractor in writing. The date of final acceptance shall commence the warranty period.
22. **LIQUIDATED DAMAGES.** If the Contractor fails to deliver the requirements by the date as set forth in the bid documents scheduled for delivery, CATA shall be paid damages for each consecutive calendar day thereafter until the goods are delivered, unless a completion date is extended by CATA in writing. Inasmuch as the amount of such damages will be extremely difficult to ascertain, the Contractor agrees to compensate CATA the sum of \$\_\_\_\_\_ per day, which sum is hereby agreed upon, fixed and determined by the parties hereto as the liquidated damages that CATA will suffer by reason of said delay and default and not as a penalty; and CATA shall have the right to deduct such sum from any amounts which may otherwise become due under contract.
23. **NO ASSIGNMENT OF CONTRACT.** Contractor may not assign or transfer any interest in the contract without the prior written consent of CATA.
24. **DEFECTIVE WORKMANSHIP AND MATERIAL.** When and as often as CATA determines that the work done or being done under the contract or the kind of quality or materials supplied in connection therewith are not fully and completely in accordance with any requirement of the contract documents, it may give notice of such noncompliance to the Contractor in writing and the Contractor shall immediately upon receipt of such notice do all things required to remedy such noncompliance without additional cost to CATA. If the Contractor fails to comply with such written notice, then CATA, upon written notice to the Contractor, shall deduct the cost of repair, replacement or correction of defective or damaged work from the compensation due or to become due to the Contractor.
25. **WAIVER OF BREACH.** The waiver by either party hereto or any breach of any provision of this contract by the other party shall not operate or be construed as a waiver of any subsequent breach of the same or any other provision of this contract by either party hereto.
26. **OWNERSHIP OF DOCUMENTS.** All original documents, calculations, and work product produced by CONTRACTOR, whether produced on paper or electronic media or otherwise in performance of this Agreement, shall be the property of CATA. CONTRACTOR shall have the right to retain a copy of such documents, calculations, and work product. CONTRACTOR shall make available to CATA copies of all CONTRACTOR correspondence, notes, and other papers relating to the work, upon request of CATA. All works of original authorship created in the scope of this Agreement are "works made for hire", as that term is used in connection with the U.S. Copyright Act. To the extent that by operation of law CONTRACTOR retains any intellectual property rights to any work product, CONTRACTOR hereby irrevocably assigns and licenses to CATA all right, title, and interest in such work product, including copyrights and patents, and agrees to execute such assignments and licenses as may be required in the opinion of CATA's legal counsel to confirm this provision. The work product produced by CONTRACTOR in the performance of services under this Agreement is intended for use by CATA solely for the purpose intended. Any use or reuse of such work product by CATA for any purpose other than its intended purpose shall be at the sole risk of CATA and without any liability or responsibility of CONTRACTOR. To the extent that the work product produced by CONTRACTOR contains standard design or construction details or other standardized material previously developed by CONTRACTOR in its professional architectural, engineering, and planning practices, then CONTRACTOR shall have the right to reuse any such material on other projects for other clients or persons without the prior knowledge or permission of CATA and without the payment of any compensation to CATA, provided that the reuse or continued use of such material contains no CATA identifying information or confidential information.
27. **EXCUSES FOR FAILURE TO PERFORM OR DELAYS.** The Contractor will not be in default by reason of any failure in the performance of this contract, if such failure arises out of causes beyond the control and without the fault or negligence of Contractor. Such causes may include, but are not limited to, acts of God or the public enemy, acts of the government either in its sovereign or contractual capacity, fires, floods, and strikes. But in every case, a failure to perform must be beyond the control and without the fault or negligence of the Contractor or its Subcontractors. An excusable delay will permit the Contractor an extension of time for such reasonable period as may be mutually agreed upon between the parties.
28. **COMPUTATION OF TIME.** In computing a period of time prescribed by these conditions, the following rules apply:
- (a) "Day" means days of the week (e.g., Monday through Friday), not business days.
  - (b) The day of the act or event after which the designated period of time begins is not included.

(c) The last day of the period is included, unless it is a Saturday, Sunday, or legal holiday. In that event, the period runs until the end of the next day that is not a Saturday, Sunday or legal holiday.

29. NOTICE. All notices and other communications required under this Contract shall be given in writing, signed by an authorized representative, and be personally delivered or delivered by overnight courier, or certified mail (return receipt requested) to the addresses set forth below:

To CATA: Chief Executive Officer  
Capital Area Transportation Authority  
4615 Tranter Street  
Lansing, MI 48910

To Contractor \_\_\_\_\_  
\_\_\_\_\_  
\_\_\_\_\_

With a copy to: \_\_\_\_\_  
\_\_\_\_\_  
\_\_\_\_\_

30. JURISDICTION. This Contract will be governed by the internal laws of the State of Michigan without reference to its choice of law rules. Exclusive jurisdiction and venue of any suit, action or claim relating to this contract will be in the Ingham County Circuit Court or the Federal District Court for the Western District of Michigan.

31. This contract constitutes the entire contract between the parties and supersedes all negotiations, commitments, and previous contracts and may be modified only by a further written contract which is executed by a duly authorized officer of each of the parties.

32. COST COMPUTATION. The Federal Acquisition Regulation, 48 CFR, Chapter 1, Part 31.2, shall be used, in all instances, to determine the amount of costs incurred by Contractor that CATA shall be required to pay, or reimburse, to Contractor, including, without limitation, where this Agreement requires CATA to pay Contractor's costs as part of the contract price, where the contract price is adjusted resulting from changes to the requirements of Agreement, and when calculating the amount due Contractor pursuant to Termination for Convenience clause.

33. TRAVEL EXPENSES. CATA shall not reimburse Contractor for travel costs, including accommodations, meals, transportation and fuel costs, unless the travel activity and the travel costs have been approved in advance by an authorized representative of CATA. All travel costs to be paid by CATA shall not exceed amounts determined in conformance with the Federal Acquisition Regulation, 48 CFR Section 31.205-46, Travel Costs.

**B. TERMS INCLUDED IN CONTRACTS FUNDED IN WHOLE OR PART BY FTA, MDOT, OR OTHER GOVERNMENTAL AGENCY.**

**1. NONDISCRIMINATION.**

(a) Compliance with Regulations. Contractor shall comply with Federal Regulations relative to nondiscrimination of the Department of Transportation, Title 49, Code of Federal Regulations, Part 21, and Title 23, Code of Federal Regulations, Part 710.405(b), as they may be amended from time to time (hereinafter referred to as the Regulations), and with Executive Order 11246 titled Equal Employment opportunity, as amended by Executive Order 11375, and as supplemented by Department of Labor Regulation (41 CFR 60) which are herein incorporated by reference and made a part of this contract. Contractor agrees that it will comply with the requirements of U.S. Equal Employment Opportunity Commission, "Regulations to Implement the Equal Employment Provisions of the Americans with Disabilities Act," 29 CFR Part 1630, pertaining to employment of persons with disabilities. In addition, Contractor agrees to comply with any implementing requirements FTA may issue.

(b) Nondiscrimination. With regard to the work performed by it during this contract, Contractor shall not discriminate on the grounds of race, color, sex, disability, religion, age, or national origin against any employee or applicant for employment or in the selection and retention of Subcontractors, including procurement of materials and leases of equipment. Contractor shall not participate either directly or indirectly in discrimination prohibited by Section 21.5 and Part 710.405(b) of the Regulations, including employment practices when the contract covers a program set forth in Appendix B of the Regulations.

(c) In connection with the performance of services under this contract, Contractor agrees to comply with the State of Michigan provisions for "prohibition of discrimination in state contracts" as set forth in Appendix A dated March 19, 1998, a copy of which is attached hereto and made a part hereof.

(d) ADA Access. All work performed and all services provided pursuant to this contract shall be in compliance with Federal policy to ensure that elderly individuals and individuals with disabilities have an equal right to

use of public transportation services and facilities. To the extent this Contract requires planning and design of services and facilities, special efforts shall be made to implement the transportation and accessibility rights of elderly individuals and individuals with disabilities. The work performed and services provided in this Contract shall be in compliance with all State and Federal statutes and laws ensuring equal access of transportation services and facilities for the elderly and individuals with disabilities, including 49 USC § 5301(d), § 504 of the Rehabilitation Act of 1973, as amended, 29 USC § 794, The Americans with Disabilities Act of 1990, as amended, 42 USC § 12101 et seq, and the Architectural Barriers Act of 1968, as amended, 42 USC § 4151 et seq, and any applicable implementing Federal regulations or directives as they may from time to time be promulgated or amended.

- (e) This provision B.1 (a)-(e) will be included in all subcontracts relating to this contract. Further, each contract which Contractor signs with a Subcontractor must include the following assurance:

The Contractor, Subrecipient, or Subcontractor shall not discriminate on the basis of race, color, national origin, creed, disability, or sex in the performance of this contract. The Contractor shall carry out applicable requirements of 49 CFR Part 26 in the award and administration of US DOT-assisted contracts. Failure by the Contractor to carry out these requirements is a material breach of this contract, which may result in the termination of this contract or such other remedy as the recipient deems appropriate.

## 2. DBE REQUIREMENTS.

- (a) Contractor will carry out the applicable requirements of the Michigan Department of Transportation's Disadvantaged Business Enterprise ("DBE") program and 49 CFR 26, including, but not limited to those requirements set forth in Appendix B, attached hereto and made a part hereof. Failure by the Contractor to carry out these requirements is a material breach of this Contract, which may result in the termination of this Contract or such other remedy as CATA deems appropriate, which may include, but is not limited to, withholding monthly progress payments, assessing sanctions, liquidated damages and/or disqualifying the Contractor from future bidding as non-responsible.
- (b) Contractor shall pay its subcontractors performing work related to this contract for satisfactory performance of that work no later than thirty (30) days after the Contractor's receipt of payment for that work from CATA. In addition, Contractor shall return any retainage payments to those subcontractors within thirty (30) days after the subcontractor's work related to this contract is satisfactorily completed. Contractor must promptly notify CATA whenever a DBE subcontractor performing work related to this contract is terminated or fails to complete the work, and must make good faith efforts to engage another DBE subcontractor to perform at least the same amount of work. The Contractor may not terminate any DBE subcontractor and perform that work through its own forces or those of an affiliate without prior written consent of CATA.

3. **CONTINGENT FEES.** The Contractor warrants that it has not employed or retained any company or person, other than a bonafide employee working solely for the Contractor, to solicit or secure this contract and that it has not paid or agreed to pay any company or person, other than a bonafide employee working solely for the Contractor, any fee, commission, percentage, brokerage fee, gifts or any other consideration, contingent upon or resulting from the award or making of this contract. For breach or violation of this warranty, CATA shall have the right to annul this contract without liability.
4. **RECORDS/AUDITS.** The Contractor shall maintain and retain, and shall require all its subcontractors to maintain and retain, complete and accurate books, documents, papers, accounting records, contracts, and other evidence with respect to allowable costs incurred and manpower expended under this contract. All such records shall be maintained on the basis of generally-accepted accounting principles and shall be clearly identified and readily accessible. The Contractor shall provide during regular business hours to the U.S. Secretary of Transportation, the FTA Administrator, the Comptroller General of the United States, and CATA, or their duly authorized representatives, access to such data and records, and the right to inspect and audit all data and records of the Contractor relating to its performance under the contract, and to make transcripts therefrom as necessary. Contractor shall retain all work data, documents, records, accounts and reports related to this contract for a period of three (3) years from the date of final payment under this contract or from expiration or other termination of this contract. In the event of a dispute as to allowable costs or any other issue under this contract, Contractor will thereafter continue to maintain such records until the dispute has been resolved.
5. **CONFLICT OF INTEREST.** The Contractor certifies that, to the best of its knowledge, no CATA employee or office of any public agency interested in this contract has any pecuniary interest in the business of the Contractor and that no person associated with the Contractor has any interest that would conflict in any manner or degree with the performance of this contract.
6. **INTEREST OF MEMBER OF CONGRESS OR DELEGATES TO CONGRESS.** No member of Congress or delegates to the Congress of the United States shall be admitted to any share or part of the contract, or to any benefit arising therefrom. This shall not be construed to prevent any such person from owning stock in a publicly owned corporation.

7. **DEBARMENT AND SUSPENSION.** Contractor must comply with U.S. DOT regulations "Nonprocurement Suspension and Debarment", 2 CFR Part 1200, which adopt and supplement the U.S. Office of Management and Budget ("U.S. OMB") "Guidelines to Agencies on Governmentwide Debarment and Suspension (Nonprocurement)," 2 CFR Part 180. Contractor will not make any contract, subcontract, or lease for the project without first confirming that its proposed contractor, subcontractor, or lessee is not listed as barred or excluded from participating in government contracts in the System for Award Management (SAM) at [www.sam.gov](http://www.sam.gov).

Contractor agrees to comply with federal debarment and suspension regulations and guidelines when administering any contract or subcontract of \$25,000 or more, regardless of tier. A contract or subcontract award may not be made to a prospective contractor or subcontractor if that contractor is excluded or disqualified under the standards of the U.S. DOT regulations in the U.S. OMB Guidelines, unless the federal government has provided an exception as permitted under those regulations and guidelines. In addition, contracts of any amount for federally required audit services or for contracts which require the consent of a federal official are also covered by these DOT regulations and U.S. OMB Guidelines. Contractor must obtain the compliance of lower tier contractors, subcontractors, and lessees with the U.S. DOT debarment and suspension regulations and the U.S. OMB Guidelines that apply to them. The Contractor further agrees to include provisions requiring compliance as set forth above in lower tier covered transactions.

8. **MDOT AND FTA TERMS.** All contractual provisions that the Michigan Department of Transportation ("MDOT") or the Federal Transit Administration ("FTA"), by law or regulation, require to be included in contracts supported by state or federal financial assistance, including the requirements set forth in FTA Circular 4220.1F, as updated and amended, and the Master Agreement between CATA and FTA as it may be amended, are hereby incorporated by reference. FTA required terms and MDOT required terms shall be deemed to control in the event of a conflict with other provisions contained in this contract. Contractor shall not refuse to comply with any CATA request to conform this contract to include MDOT or FTA required contractual provisions. The Contractor shall not perform any act, fail to perform any act, or refuse to comply with any CATA requests which would cause CATA to be in violation of the FTA mandated contractual provisions.
9. **COMPLIANCE WITH LAWS.** The Contractor shall at all times observe and comply with all laws, ordinances, and regulations of the state, federal, local, and city government which may, in any manner, affect the performance of the contract.
10. **CLEAN AIR.** The Contractor agrees to comply with all applicable standards, orders or regulations issued pursuant to the Clean Air Act, as amended, 42 U.S.C. 7401, *et seq.* If state or local air pollution regulations are in force, the more restrictive criteria shall govern. The Contractor and any subcontractors or suppliers must submit evidence to CATA that the governing air pollution criteria will be met. The Contractor agrees to report each violation to CATA and understands and agrees that CATA will, in turn, report each violation as required to FTA and the appropriate EPA Regional Office. The Contractor also agrees to include these requirements in each subcontract exceeding \$150,000 financed in whole or in part with Federal assistance provided by FTA.
11. **BUY AMERICA PROVISIONS.** Contractor agrees to comply with 49 U.S.C. 5323(j) and FTA's Buy America Regulations in 49 CFR Part 661. These require that iron, steel, and manufactured products used in FTA funded projects be produced in the United States, with specific provisions that apply to rolling stock procurements, unless a waiver has been granted by FTA or the product is subject to a general waiver. The continued accuracy of the certificate, attached as Appendix C, entitled "Buy America Certification", submitted with Contractor's proposal/bid is a term and condition of this Agreement.
12. **CERTIFICATION REGARDING LOBBYING.** N/A
13. **FEDERAL WAGE REQUIREMENTS FOR CONSTRUCTION CONTRACTS.**
- (a) This procurement is subject to the Davis-Bacon Act, 40 USC § 3141, *et seq.*, and to the Copeland Anti-Kickback Act, 18 USC § 874, and to the regulations promulgated thereunder ("the Acts"). As required by federal regulations promulgated under the Acts, the following provisions set forth in Paragraph 13(b) and (c) are incorporated into the Agreement, with the understanding that the term "contracting officer" refers to the appointed representative of CATA.
- (b) **Davis-Bacon and Copeland Anti-Kickback Acts**

(1) **Minimum wages**

(i) All laborers and mechanics employed or working under the site of the work (or under the United States Housing Act of 1937 or under the Housing Act of 1949 in the construction or development of the project), will be paid unconditionally and not less often than once a week, and without subsequent deduction or rebate on any account (except such payroll deductions as are permitted by regulations issued by the Secretary of Labor under the Copeland Act (29 CFR part 3)), the full amount of wages and bona fide fringe benefits (or cash equivalents thereof) due at time of payment computed at rates not less than those contained in the wage determination of the Secretary of Labor which is attached hereto and made a part hereof, regardless of any contractual relationship which may be alleged to exist between the Contractor and such laborers and mechanics.

Contributions made or costs reasonably anticipated for bona fide fringe benefits under section 1(b)(2) of the Davis-Bacon Act on behalf of laborers or mechanics are considered wages paid to such laborers or mechanics, subject to the provisions of paragraph (1)(iv) of this section; also, regular contributions made or costs incurred for more than a weekly period (but not less often than quarterly) under plans, funds, or programs which cover the particular weekly period, are deemed to be constructively made or incurred during such weekly period. Such laborers and mechanics shall be paid the appropriate wage rate and fringe benefits on the wage determination for the classification of work actually performed, without regard to skill, except as provided in 29 CFR Part 5.5(a)(4). Laborers or mechanics performing work in more than one classification may be compensated at the rate specified for each classification for the time actually worked therein: Provided, That the employer's payroll records accurately set forth the time spent in each classification in which work is performed. The wage determination (including any additional classifications and wage rates conformed under paragraph (1)(ii) of this section) and the Davis-Bacon poster (WH-1321) shall be posted at all times by the Contractor and its subcontractors at the site of the work in a prominent and accessible place where it can be easily seen by the workers.

(ii)(A) The contracting officer shall require that any class of laborers or mechanics, including helpers, which is not listed in the wage determination and which is to be employed under the contract shall be classified in conformance with the wage determination. The contracting officer shall approve an additional classification and wage rate and fringe benefits therefore only when the following criteria have been met:

(1) Except with respect to helpers as defined as 29 CFR 5.2(n)(4), the work to be performed by the classification requested is not performed by a classification in the wage determination; and

(2) The classification is utilized in the area by the construction industry; and

(3) The proposed wage rate, including any bona fide fringe benefits, bears a reasonable relationship to the wage rates contained in the wage determination; and

(4) With respect to helpers as defined in 29 CFR 5.2(n)(4), such a classification prevails in the area in which the work is performed.

(B) If the Contractor and the laborers and mechanics to be employed in the classification (if known), or their representatives, and the contracting officer agree on the classification and wage rate (including the amount designated for fringe benefits where appropriate), a report of the action taken shall be sent by the contracting officer to the Administrator of the Wage and Hour Division, Employment Standards Administration, U.S. Department of Labor, Washington, DC 20210. The Administrator, or an authorized representative, will approve, modify, or disapprove every additional classification action within 30 days of receipt and so advise the contracting officer or will notify the contracting officer within the 30-day period that additional time is necessary.

(C) In the event the Contractor, the laborers or mechanics to be employed in the classification or their representatives, and the contracting officer do not agree on the proposed classification and wage rate (including the amount designated for fringe benefits, where appropriate), the contracting officer shall refer the questions, including the views of all interested parties and the recommendation of the contracting officer, to the Administrator for determination. The Administrator, or an authorized representative, will issue a determination within 30 days of receipt and so advise the contracting officer or will notify the contracting officer within the 30-day period that additional time is necessary.

(D) The wage rate (including fringe benefits where appropriate) determined pursuant to paragraphs (a)(1)(ii) (B) or (C) of this section, shall be paid to all workers performing work in the classification under this contract from the first day on which work is performed in the classification.

(iii) Whenever the minimum wage rate prescribed in the contract for a class of laborers or mechanics includes a fringe benefit which is not expressed as an hourly rate, the Contractor shall either pay the benefit as stated in the wage determination or shall pay another bona fide fringe benefit or an hourly cash equivalent thereof.

(iv) If the Contractor does not make payments to a trustee or other third person, the Contractor may consider as part of the wages of any laborer or mechanic the amount of any costs reasonably anticipated in providing bona fide fringe benefits under a plan or program, Provided, That the Secretary of Labor has found, upon the written request of the Contractor, that the applicable standards of the Davis-Bacon Act have been met. The Secretary of Labor may require the Contractor to set aside in a separate account assets for the meeting of obligations under the plan or program.

(v) (A) The contracting officer shall require that any class of laborers or mechanics which is not listed in the wage determination and which is to be employed under the contract shall be classified in conformance with the wage determination. The contracting officer shall approve an additional classification and wage rate and fringe benefits therefore only when the following criteria have been met:

- (1) The work to be performed by the classification requested is not performed by a classification in the wage determination; and
  - (2) The classification is utilized in the area by the construction industry; and
  - (3) The proposed wage rate, including any bona fide fringe benefits, bears a reasonable relationship to the wage rates contained in the wage determination.
- (B) If the Contractor and the laborers and mechanics to be employed in the classification (if known), or their representatives, and the contracting officer agree on the classification and wage rate (including the amount designated for fringe benefits where appropriate), a report of the action taken shall be sent by the contracting officer to the Administrator of the Wage and Hour Division, Employment Standards Administration, Washington, DC 20210. The Administrator, or an authorized representative, will approve, modify, or disapprove every additional classification action within 30 days of receipt and so advise the contracting officer or will notify the contracting officer within the 30-day period that additional time is necessary.
- (C) In the event the Contractor, the laborers or mechanics to be employed in the classification or their representatives, and the contracting officer do not agree on the proposed classification and wage rate (including the amount designated for fringe benefits, where appropriate), the contracting officer shall refer the questions, including the views of all interested parties and the recommendation of the contracting officer, to the Administrator for determination. The Administrator, or an authorized representative, will issue a determination with 30 days of receipt and so advise the contracting officer or will notify the contracting officer within the 30-day period that additional time is necessary.
- (D) The wage rate (including fringe benefits where appropriate) determined pursuant to paragraphs (a)(1)(v) (B) or (C) of this section, shall be paid to all workers performing work in the classification under this contract from the first day on which work is performed in the classification.
- (2) **Withholding** - Owner shall upon its own action or upon written request of an authorized representative of the Department of Labor withhold or cause to be withheld from the Contractor under this contract or any other Federal contract with the same prime contractor, or any other federally-assisted contract subject to Davis-Bacon prevailing wage requirements, which is held by the same prime contractor, so much of the accrued payments or advances as may be considered necessary to pay laborers and mechanics, including apprentices, trainees, and helpers, employed by the Contractor or any subcontractor the full amount of wages required by the contract. In the event of failure to pay any laborer or mechanic, including any apprentice, trainee, or helper, employed or working on the site of the work (or under the United States Housing Act of 1937 or under the Housing Act of 1949 in the construction or development of the project), all or part of the wages required by the contract, Owner may, after written notice to the Contractor, sponsor, applicant, or agency, take such action as may be necessary to cause the suspension of any further payment, advance, or guarantee of funds until such violations have ceased.
- (3) **Payrolls and basic records**
- (i) Payrolls and basic records relating thereto shall be maintained by the Contractor during the course of the work and preserved for a period of three years thereafter for all laborers and mechanics working at the site of the work (or under the United States Housing Act of 1937, or under the Housing Act of 1949, in the construction or development of the project). Such records shall contain the name, address, and social security number of each such worker, his or her correct classification, hourly rates of wages paid (including rates of contributions or costs anticipated for bona fide fringe benefits or cash equivalents thereof of the types described in section 1(b)(2)(B) of the Davis-Bacon Act), daily and weekly number of hours worked, deductions made and actual wages paid. Whenever the Secretary of Labor has found under 29 CFR 5.5(a)(1)(iv) that the wages of any laborer or mechanic include the amount of any costs reasonably anticipated in providing benefits under a plan or program described in section 1(b)(2)(B) of the Davis-Bacon Act, the Contractor shall maintain records which show that the commitment to provide such benefits is enforceable, that the plan or program is financially responsible, and that the plan or program has been communicated in writing to the laborers or mechanics affected, and records which show the costs anticipated or the actual cost incurred in providing such benefits. Contractor's employing apprentices or trainees under approved programs shall maintain written evidence of the registration of apprenticeship programs and certification of trainee programs, the registration of the apprentices and trainees, and the ratios and wage rates prescribed in the applicable programs.
  - (ii) (A) The Contractor shall submit weekly for each week in which any contract work is performed a copy of all payrolls to Owner for transmission to the Federal Transit Administration. The payrolls submitted shall set out accurately and completely all of the information required to be maintained under section 5.5(a)(3)(i) of Regulations, 29 CFR part 5. This information may be submitted in any form desired. Optional Form WH-347 is available for this purpose and may be purchased from the Superintendent of

Documents (Federal Stock Number 029-005-00014-1), U.S. Government Printing Office, Washington, DC 20402. The prime contractor is responsible for the submission of copies of payrolls by all subcontractors.

(B) Each payroll submitted shall be accompanied by a "Statement of Compliance," signed by the Contractor or subcontractor or his or her agent who pays or supervises the payment of the persons employed under the contract and shall certify the following:

(1) That the payroll for the payroll period contains the information required to be maintained under section 5.5(a)(3)(i) of Regulations, 29 CFR part 5 and that such information is correct and complete;

(2) That each laborer or mechanic (including each helper, apprentice, and trainee) employed on the contract during the payroll period has been paid the full weekly wages earned, without rebate, either directly or indirectly, and that no deductions have been made either directly or indirectly from the full wages earned, other than permissible deductions as set forth in Regulations, 29 CFR part 3;

(3) That each laborer or mechanic has been paid not less than the applicable wage rates and fringe benefits or cash equivalents for the classification of work performed, as specified in the applicable wage determination incorporated into the contract.

(C) The weekly submission of a properly executed certification set forth on the reverse side of Optional Form WH-347 shall satisfy the requirement for submission of the "Statement of Compliance" required by paragraph (a)(3)(ii)(B) of this section.

(D) The falsification of any of the above certifications may subject the Contractor or subcontractor to civil or criminal prosecution under section 1001 of title 18 and section 231 of title 31 of the United States Code.

(iii) The Contractor or subcontractor shall make the records required under paragraph (a)(3)(i) of this section available for inspection, copying, or transcription by authorized representatives of the Federal Transit Administration or the Department of Labor, and shall permit such representatives to interview employees during working hours on the job. If the Contractor or subcontractor fails to submit the required records or to make them available, the Federal agency may, after written notice to the Contractor, sponsor, applicant, or agency, take such action as may be necessary to cause the suspension of any further payment, advance, or guarantee of funds. Furthermore, failure to submit the required records upon request or to make such records available may be grounds for debarment action pursuant to 29 CFR 5.12.

#### (4) Apprentices and trainees

(i) Apprentices - Apprentices will be permitted to work at less than the predetermined rate for the work they performed when they are employed pursuant to and individually registered in a bona fide apprenticeship program registered with the U.S. Department of Labor, Employment and Training Administration, Bureau of Apprenticeship and Training, or with a State Apprenticeship Agency recognized by the Bureau, or if a person is employed in his or her first 90 days of probationary employment as an apprentice in such an apprenticeship program, who is not individually registered in the program, but who has been certified by the Bureau of Apprenticeship and Training or a State Apprenticeship Agency (where appropriate) to be eligible for probationary employment as an apprentice. The allowable ratio of apprentices to journeymen on the job site in any craft classification shall not be greater than the ratio permitted to the Contractor as to the entire work force under the registered program. Any worker listed on a payroll at an apprentice wage rate, who is not registered or otherwise employed as stated above, shall be paid not less than the applicable wage rate on the wage determination for the classification of work actually performed. In addition, any apprentice performing work on the job site in excess of the ratio permitted under the registered program shall be paid not less than the applicable wage rate on the wage determination for the work actually performed. Where a contractor is performing construction on a project in a locality other than that in which its program is registered, the ratios and wage rates (expressed in percentages of the journeyman's hourly rate) specified in the Contractor's or subcontractor's registered program shall be observed. Every apprentice must be paid at not less than the rate specified in the registered program for the apprentice's level of progress, expressed as a percentage of the journeymen hourly rate specified in the applicable wage determination. Apprentices shall be paid fringe benefits in accordance with the provisions of the apprenticeship program. If the apprenticeship program does not specify fringe benefits, apprentices must be paid the full amount of fringe benefits listed on the wage determination for the applicable classification. If the Administrator of the Wage and Hour Division of the U.S. Department of Labor determines that a different practice prevails for the applicable apprentice classification, fringes shall be paid in accordance with that determination. In the event the Bureau of Apprenticeship and Training, or a State Apprenticeship Agency recognized by the Bureau, withdraws approval of an apprenticeship program, the Contractor will no longer be permitted to utilize apprentices at less than the applicable predetermined rate for the work performed until an acceptable program is approved.

(ii) Trainees - Except as provided in 29 CFR 5.16, trainees will not be permitted to work at less than the predetermined rate for the work performed unless they are employed pursuant to and individually registered in a program which has received prior approval, evidenced by formal certification by the U.S. Department of Labor, Employment and Training Administration. The ratio of trainees to journeymen on the job site shall not be greater than permitted under the plan approved by the Employment and Training Administration. Every trainee must be paid at not less than the rate specified in the approved program for the trainee's level of progress, expressed as a percentage of the journeyman hourly rate specified in the applicable wage determination. Trainees shall be paid fringe benefits in accordance with the provisions of the trainee program. If the trainee program does not mention fringe benefits, trainees shall be paid the full amount of fringe benefits listed on the wage determination unless the Administrator of the Wage and Hour Division determines that there is an apprenticeship program associated with the corresponding journeyman wage rate on the wage determination which provides for less than full fringe benefits for apprentices. Any employee listed on the payroll at a trainee rate who is not registered and participating in a training plan approved by the Employment and Training Administration shall be paid not less than the applicable wage rate on the wage determination for the classification of work actually performed. In addition, any trainee performing work on the job site in excess of the ratio permitted under the registered program shall be paid not less than the applicable wage rate on the wage determination for the work actually performed. In the event the Employment and Training Administration withdraws approval of a training program, the Contractor will no longer be permitted to utilize trainees at less than the applicable predetermined rate for the work performed until an acceptable program is approved.

(iii) Equal employment opportunity - The utilization of apprentices, trainees and journeymen under this part shall be in conformity with the equal employment opportunity requirements of Executive Order 11246, as amended, and 29 CFR part 30.

(5) **Compliance with Copeland Act requirements** - The Contractor shall comply with the requirements of 29 CFR part 3, which are incorporated by reference in this contract.

(6) **Subcontracts** - The Contractor or subcontractor shall insert in any subcontracts the clauses contained in 29 CFR 5.5(a)(1) through (10) and such other clauses as the Federal Transit Administration may by appropriate instructions require, and also a clause requiring the subcontractors to include these clauses in any lower tier subcontracts. The prime contractor shall be responsible for the compliance by any subcontractor or lower tier subcontractor with all the contract clauses in 29 CFR 5.5.

(7) **Contract termination: debarment** - A breach of the contract clauses in 29 CFR 5.5 may be grounds for termination of the contract, and for debarment as a Contractor and a subcontractor as provided in 29 CFR 5.12.

(8) **Compliance with Davis-Bacon and Related Act requirements** - All rulings and interpretations of the Davis-Bacon and Related Acts contained in 29 CFR parts 1, 3, and 5 are herein incorporated by reference in this contract.

(9) **Disputes concerning labor standards** - Disputes arising out of the labor standards provisions of this contract shall not be subject to the general disputes clause of this contract. Such disputes shall be resolved in accordance with the procedures of the Department of Labor set forth in 29 CFR parts 5, 6, and 7. Disputes within the meaning of this clause include disputes between the Contractor (or any of its subcontractors) and the contracting agency, the U.S. Department of Labor, or the employees or their representatives.

(10) **Certification of eligibility**

(i) By entering into this contract, the Contractor certifies that neither it (nor he or she) nor any person or firm who has an interest in the Contractor's firm is a person or firm ineligible to be awarded Government contracts by virtue of section 3(a) of the Davis-Bacon Act or 29 CFR 5.12(a)(1).

(ii) No part of this contract shall be subcontracted to any person or firm ineligible for award of a Government contract by virtue of section 3(a) of the Davis-Bacon Act or 29 CFR 5.12(a)(1).

(iii) The penalty for making false statements is prescribed in the U.S. Criminal Code, 18 U.S.C. 1001.

14. BID BOND. N/A

15. PROTESTS. Any protests shall be filed timely in accordance with the CATA Procurement Protest Procedures. These Procedures are available from the CATA Purchasing & Contracts Manager and the CATA CEO/Executive Director, at the following address: Capital Area Transportation Authority, 4615 Tranter Street, Lansing, MI 48910.

16. PERFORMANCE & PAYMENT BONDS. N/A

17. FEDERAL CHANGES. Contractor shall at all times comply with all applicable FTA regulations, policies, procedures and directives, including without limitation those listed directly or by reference in the Master Agreement between CATA and FTA, as they may be amended or promulgated from time to time during the term of this contract. Contractor shall

not, by action or by inaction, cause CATA to be in violation of FTA regulations, policies, procedures, or directives. Contractor's failure to comply with this paragraph shall constitute a material breach of this contract.

18. NO GOVERNMENT OBLIGATION. Notwithstanding any concurrence by the Federal Government or MDOT in, or approval of, the solicitation or award of this Agreement, absent the express written consent by the Federal Government or by MDOT, neither the Federal Government nor the State of Michigan is a party to this Agreement, and neither shall be subject to any obligations or liabilities to CATA, the Contractor or any other party (whether or not a party to this Agreement) pertaining to any matter resulting from this Agreement. The Contractor agrees to include this clause in each subcontract financed in whole or in part with Federal assistance provided by FTA. It is further agreed that the clause shall not be modified, except to identify the subcontractor who will be subject to its provisions.
19. CLEAN WATER. N/A
20. SEISMIC SAFETY. The Contractor agrees that any new building or addition to an existing building will be designed and constructed in accordance with the standards for Seismic Safety required in Department of Transportation Seismic Safety Regulations 49 CFR Part 41 and will certify to compliance to the extent required by the regulation. The Contractor also agrees to ensure that all work performed under this Contract including work performed by a subcontractor is in compliance with the standards required by the Seismic Safety Regulations and the certification of compliance issued on the project.
21. ENERGY CONSERVATION. The Contractor agrees to comply with mandatory standards and policies relating to energy efficiency which are contained in the state energy conservation plan issued in compliance with the Energy Policy and Conservation Act.
22. RECOVERED MATERIALS. The Contractor agrees to comply with all requirements of Section 6002 of the Resource Conservation and Recovery Act ("RCRA"), as amended (42 USC 6962), including but not limited to the regulatory provisions of 40 CFR Part 247, and Executive Order 12873, as they apply to the procurement of the items designated in subpart B of 40 CFR Part 247.
23. FLY AMERICA REQUIREMENTS. Contractor agrees to comply with 49 U.S.C. 40118 ("Fly America Act") in accordance with the General Services Administration's regulations at 41 CFR Part 301-10, which provide that recipients and subrecipients of federal funds and their contractors are required to use United States Flag air carriers for U.S. Government financed international air travel and transportation of their personal effects or property, to the extent such service is available, unless travel by foreign air carrier is a matter of necessity, as defined by the Fly America Act. The Contractor shall submit, if a foreign air carrier was used, an appropriate certification or memorandum adequately explaining why service by a United States Flag air carrier was not available or why it was necessary to use a foreign air carrier and shall, in any event, provide a certificate of compliance with the Fly America requirements. The Contractor agrees to include the requirements of this section in all subcontracts that may involve international air transportation.
24. CARGO PREFERENCE. The Contractor agrees (a) to use privately owned United States Flag commercial vessels to ship at least 50% of the gross tonnage (computed separately for dry bulk carriers, dry cargo liners, and tankers) involved, whenever shipping any equipment, material, or commodities pursuant to the underlying contract to the extent such vessels are available at fair and reasonable rates for United States Flag commercial vessels; (b) to furnish within twenty (20) working days following the date of loading of shipments originating within the United States or within thirty (30) working days following the date of loading for shipments originating outside the United States, a legible copy of the rated, "on-board" commercial ocean bill of lading, in English, for each shipment of cargo described in the preceding paragraph to the Division of National Cargo, Office of Market Development, Maritime Administration, Washington, D.C., 20590. CATA (through the Contractor in the case of a subcontractor's bill of lading); and (c) to include these requirements in all subcontracts issued pursuant to this contract where the subcontract may involve the transport of equipment, material, or commodities by ocean vessel.
25. PROGRAM FRAUD AND FALSE OR FRAUDULENT STATEMENTS OR RELATED ACTS.
  - (a) The Contractor acknowledges that the provisions of the Program Fraud Civil Rights Act of 1986, as amended, 31 U.S.C. § 3801 *et seq.* and U.S. DOT regulations, "Program Fraud Civil Remedies," 49 C.F.R. Part 31, apply to its actions pertaining to this Project. Upon execution of the underlying contract, the Contractor certifies or affirms the truthfulness and accuracy of any statement it has made, it makes, or may make, or causes to be made, pertaining to the underlying contract or the FTA assisted project for which this contract work is being performed. In addition to other penalties that may be applicable, the Contractor further acknowledges that if it makes, or causes to be made, a false, fictitious, or fraudulent claim, statement, submission, or certification, the Federal Government reserves the right to impose the penalties of the Program Fraud Civil Remedies Act of 1986 on the Contractor to the extent the Federal Government deems appropriate.
  - (b) The Contractor also acknowledges that if it makes, or causes to be made, a false, fictitious, or fraudulent claim, statement, submission, or certification to the Federal Government under a contract connected with a project that is financed in whole or in part with Federal assistance originally awarded by FTA under authority of 49 U.S.C. § 5307, the Federal Government reserves the right to impose the penalties of 18 U.S.C. § 1001

and 49 U.S.C. § 5307(n)(1) on the Contractor, or the applicable Federal law to the extent the Federal Government deems appropriate.

- (c) The Contractor agrees to include the above two clauses in each subcontract financed in whole or in part with Federal assistance by FTA. It is further agreed that the clauses shall not be modified, except to identify the subcontractor who will be subject to the provisions.

## 26. SAFE OPERATIONS OF MOTOR VEHICLES

- (a) Seat Belt Use – Contractor is encouraged to adopt and promote on-the-job seat belt use policies and programs for its employees and other personnel that operate company-owned vehicles, company-rented vehicles, or personally operated vehicles. The terms “company-owned” and “company-leased” refer to vehicles owned or leased either by the Contractor or CATA.
- (b) Distracted Driving – Contractor agrees to adopt and enforce workplace safety policies to decrease crashes caused by distracted drivers, including policies to ban text messaging while using an electronic device supplied by an employer and driving a vehicle the driver owns or rents, a vehicle either Contractor or CATA owns, leases, or rents, or a privately-owned vehicle when on official business in connection with the work performed under this Agreement

27. VETERANS EMPLOYMENT. Contractors working on a federally funded project give a hiring preference, to the extent practicable, to veterans (as defined in 5 USC §2108) who have the requisite skills and abilities to perform the construction work required under the contract. This provision shall not be understood, construed, or enforced in any manner that would require an employer to give preference to any veteran over any equally qualified applicant who is a member any racial or ethnic minority, female, an individual with a disability, or former employee.

**APPENDIX A****PROHIBITION OF DISCRIMINATION IN STATE CONTRACTS**

In connection with the performance of work under this contract, Contractor agrees as follows:

1. In accordance with Act 453, Public Acts of 1976, Contractor hereby agrees not to discriminate against an employee or applicant for employment with respect to hire, tenure, terms, conditions, or privileges of employment, or as a matter directly or indirectly related to employment, because of race, color, religion, national origin, age, sex, height, weight, or marital status. Further, in accordance with Act No. 220, Public Acts of 1976 as amended by Act No. 478, Public Acts of 1980, Contractor hereby agrees not to discriminate against an employee or applicant for employment with respect to hire, tenure, terms, conditions, or privileges of employment, or a matter directly or indirectly related to employment, because of a disability that is unrelated to the individual's ability to perform the duties of a particular job or position. A breach of the above covenants shall be regarded as a material breach of this contract.
2. Contractor hereby agrees that any and all subcontracts to this contract, whereby a portion of the work set forth in this contract is to be performed, shall contain a covenant the same as hereinabove set forth in Section 1 of this Appendix.
3. Contractor will take affirmative action to insure that applicants for employment and employees are treated without regard to their race, color, religion, national origin, age, sex, height, weight, marital status or a disability that is unrelated to the individual's ability to perform the duties of a particular job or position. Such action shall include, but not be limited to the following: employment, upgrading, demotion or transfer, recruitment advertising; layoff or termination; rates of pay or other forms of compensation; and selection for training, including apprenticeship.
4. Contractor will, in all solicitations or advertisements for employees placed by or on behalf of Contractor, state that all qualified applicants will receive consideration for employment without regard to race, color, religion, national origin, age, sex, height, weight, marital status or disability that is unrelated to the individual's ability to perform the duties of a particular job or position.
5. Contractor or its collective bargaining representative will send to each labor union or representative of workers with which it has a collective bargaining agreement or other contract or understanding, a notice advising the said labor union or workers' representative of the Contractor's commitments under this appendix.
6. Contractor will comply with all relevant published rules, regulations, directives, and orders of the Michigan Civil Rights Commission which may be in effect prior to the taking of bids for any individual state project.
7. Contractor will furnish and file compliance reports within such time and upon such forms as provided by the Michigan Civil Rights Commission, said forms may also elicit information as to the practices, policies, program, and employment statistics of each subcontractor as well as Contractor itself, and said Contractor will permit access to its books, records, and accounts by the Michigan Civil Rights Commission and/or its agent, for purposes of investigation to ascertain compliance with this contract and relevant with rules, regulations, and orders of the Michigan Civil Rights Commission.
8. In the event that the Civil Rights Commission finds, after a hearing held pursuant to its rules, that Contractor has not complied with the contractual obligations under this Agreement, the Civil Rights Commission may, as part of its order based upon such findings, certify said findings to the Administrative Board of the State of Michigan, which Administrative Board may order the cancellation of the contract found to have been violated and/or declare Contractor ineligible for future contracts with the state and its political and civil subdivisions, departments, and officers, and including the governing boards of institutions of higher education, until Contractor complies with said order of the Civil Rights Commission. Notice of said declaration of future ineligibility may be given to any or all of the persons with whom Contractor is declared ineligible to contract as a contracting party in future contracts. In any case before the Civil Rights Commission in which cancellation of an existing contract is a possibility, the contracting agency shall be notified of such possible remedy and shall be given the option by the Civil Rights Commission to participate in such proceedings.
9. Contractor will include, or incorporate by reference, the provisions of the foregoing paragraphs (1) through (8) in every subcontract or purchase order unless exempted by the rules, regulations or orders of the Michigan Civil Rights Commission, and will provide in every subcontract or purchase order that said provisions will be binding upon each subcontractor or seller.

**APPENDIX B****ASSURANCES THAT CONTRACTORS AND SUBCONTRACTORS MUST MAKE PURSUANT TO US DOT  
REGULATION 49 CFR § 26, et seq**

- A. Contractor, subrecipient or subcontractor shall not discriminate on the basis of race, color, national origin, or sex, in the performance of this contract. Contractor shall carry out applicable requirements of 49 CFR § 26 in the award and administration of DOT-assisted contracts. Failure of the Contractor to carry out these requirements is a material breach of this contract, which may result in the termination of this contract or such other remedy as the recipient deems appropriate, which may include, but is not limited to:
1. Withholding monthly progress payments;
  2. Assessing sanctions;
  3. Liquidated damages; and/or
  4. Disqualifying the Contractor from further bidding as non-responsible.
- B. Each contract Contractor signs with a subcontractor must include the preceding assurance.

**POLICY #204****DISADVANTAGED BUSINESS ENTERPRISE POLICY**

The Capital Area Transportation Authority ("CATA") is committed to a policy of non-discrimination in the conduct of its business, including the procurement of goods and services. CATA will take affirmative action to assure maximum practical opportunity for participation of Disadvantaged Business Enterprise ("DBE") in the performance of contracts financed in whole or in part with funds from the United States Department of Transportation, the Federal Transit Administration ("FTA"), the Michigan Department of Transportation ("MDOT"), or other state and federal agencies with DBE programs.

The Executive Director of CATA will annually set an overall goal or goals as a "level playing field" for the amount of DBE participation that can reasonably be expected in the absence of discrimination. This goal will be based on demonstrable evidence of ready, willing, and able DBEs that are available to participate in government assisted contracts. Affirmative action shall be consistent with sound procurement principles and applicable law.

This Policy Statement will be executed by the Executive Director and the Board Chair of CATA, and then circulated to all Department Directors, and Department Managers within the organization and circulated to contracting organizations, the state offices which administer programs, and DBE organizations. The Executive Director will give public notice of DBE goals, how the goals were determined, and contact information for public comment.

CATA's Purchasing Manager shall be the DBE liaison for CATA and will be responsible for administering the program. The DBE liaison will report to the Assistant Executive Director and shall have direct access to the Executive Director, as necessary. The DBE liaison will work with all directors and department managers to insure the effective functioning of CATA's DBE program.

The efforts and results of the entire staff will be reported to the Board through the Development Report of the Executive Director.

  
Sam Singh, Board Chair

  
Sandra L. Draggoo, CEO/Executive Director

Adopted: 2/9/84  
Amended: 6/27/84  
11/14/84  
3/15/89  
10/19/05

**EXHIBIT J  
WAGE DETERMINATION**

"General Decision Number: MI20210001 09/03/2021

Superseded General Decision Number: MI20200001

State: Michigan

Construction Types: Highway (Highway, Airport & Bridge xxxxx  
and Sewer/Incid. to Hwy.)

Counties: Michigan Statewide.

Note: Under Executive Order (EO) 13658, an hourly minimum wage of \$10.95 for calendar year 2021 applies to all contracts subject to the Davis-Bacon Act for which the contract is awarded (and any solicitation was issued) on or after January 1, 2015. If this contract is covered by the EO, the contractor must pay all workers in any classification listed on this wage determination at least \$10.95 per hour (or the applicable wage rate listed on this wage determination, if it is higher) for all hours spent performing on the contract in calendar year 2021. If this contract is covered by the EO and a classification considered necessary for performance of work on the contract does not appear on this wage determination, the contractor must pay workers in that classification at least the wage rate determined through the conformance process set forth in 29 CFR 5.5(a)(1)(ii) (or the EO minimum wage rate, if it is higher than the conformed wage rate). The EO minimum wage rate will be adjusted annually. Please note that this EO applies to the above-mentioned types of contracts entered into by the federal government that are subject to the Davis-Bacon Act itself, but it does not apply to contracts subject only to the Davis-Bacon Related Acts, including those set forth at 29 CFR 5.1(a)(2)-(60). Additional information on contractor requirements and worker protections under the EO is available at [www.dol.gov/whd/govcontracts](http://www.dol.gov/whd/govcontracts).

Modification Number	Publication Date
0	01/01/2021
1	03/12/2021
2	05/07/2021
3	06/04/2021
4	06/18/2021
5	07/02/2021
6	07/09/2021
7	07/16/2021
8	07/30/2021
9	08/27/2021
10	09/03/2021

CARP0004-004 06/01/2019

REMAINDER OF STATE

	Rates	Fringes
CARPENTER ( Piledriver).....	\$ 27.62	20.59

-----  
CARP0004-005 06/01/2018

LIVINGSTON (Townships of Brighton, Deerfield, Genoa, Hartland, Oceola & Tyrone), MACOMB, MONROE, OAKLAND, SANILAC, ST. CLAIR AND WAYNE COUNTIES

	Rates	Fringes
CARPENTER (Piledriver).....	\$ 30.50	27.28

-----  
 ELEC0017-005 06/01/2021

STATEWIDE

	Rates	Fringes
Line Construction		
Groundman/Driver.....	\$ 29.11	7.20+32%
Journeyman Signal Tech, Communications Tech, Tower Tech & Fiber Optic Splicers.		
	\$ 42.55	7.20+32%
Journeyman Specialist.....	\$ 48.93	7.20+32%
Operator A.....	\$ 35.96	7.20+32%
Operator B.....	\$ 33.57	7.20+32%

Classifications

Journeyman Specialist: Refers to a crew of only one person working alone.

Operator A: Shall be proficient in operating all power equipment including: Backhoe,

Excavator, Directional Bore and Boom/Digger truck.

Operator B: Shall be proficient in operating any 2 of the above mentioned pieces of equipment listed under Operator A.

-----  
 ENGI0324-003 06/01/2021

ALCONA, ALPENA, ARENAC, BAY, CHEBOYGAN, CLARE, CLINTON, CRAWFORD, GENESEE, GLADWIN, GRATIOT, HURON, INGHAM, IOSCO, ISABELLA, JACKSON, LAPEER, LENAWEE, LIVINGSTON, MACOMB, MIDLAND, MONROE, MONTMORENCY, OAKLAND, OGEMAW, OSCODA, OTSEGO, PRESQUE ISLE, ROSCOMMON, SAGINAW, ST. CLAIR, SANILAC, SHIAWASSEE, TUSCOLA, WASHTENAW AND WAYNE COUNTIES:

	Rates	Fringes
OPERATOR: Power Equipment (Steel Erection)		
GROUP 1.....	\$ 48.02	24.85
GROUP 2.....	\$ 49.02	24.85
GROUP 3.....	\$ 46.52	24.85
GROUP 4.....	\$ 47.52	24.85
GROUP 5.....	\$ 45.02	24.85
GROUP 6.....	\$ 46.02	24.85
GROUP 7.....	\$ 44.75	24.85
GROUP 8.....	\$ 45.75	24.85
GROUP 9.....	\$ 44.30	24.85
GROUP 10.....	\$ 45.30	24.85
GROUP 11.....	\$ 43.57	24.85
GROUP 12.....	\$ 44.57	24.85

GROUP 13.....	\$ 43.21	24.85
GROUP 14.....	\$ 44.21	24.85
GROUP 15.....	\$ 42.57	24.85
GROUP 16.....	\$ 39.37	24.85
GROUP 17.....	\$ 24.89	12.00
GROUP 18.....	\$ 28.38	12.00

FOOTNOTE:

Paid Holidays: New Year's Day, Memorial Day, Fourth of July, Labor Day, Thanksgiving Day and Christmas Day.

POWER EQUIPMENT OPERATOR CLASSIFICATIONS

GROUP 1: Engineer when operating combination of boom and jib 400' or longer

GROUP 2: Engineer when operating combination of boom and jib 400' or longer on a crane that requires an oiler

GROUP 3: Engineer when operating combination of boom and jib 300' or longer

GROUP 4: Engineer when operating combination of boom and jib 300' or longer on a crane that requires an oiler

GROUP 5: Engineer when operating combination of boom and jib 220' or longer

GROUP 6: Engineer when operating combination of boom and jib 220' or longer on a crane that requires an oiler

GROUP 7: Engineer when operating combination of boom and jib 140' or longer

GROUP 8: Engineer when operating combination of boom and jib 140' or longer on a crane that requires an oiler

GROUP 9: Tower crane & derrick operator (where operator's work station is 50 ft. or more above first sub-level)

GROUP 10: Tower crane & derrick operator (where operator's work station is 50 ft. or more above first sub-level) on a crane that requires an oiler

GROUP 11: Engineer when operating combination of boom and jib 120' or longer

GROUP 12: Engineer when operating combination of boom and jib 120' or longer on a crane that requires an oiler

GROUP 13: Crane operator; job mechanic and 3 drum hoist and excavator

GROUP 14: Crane operator on a crane that requires an oiler

GROUP 15: Hoisting operator; 2 drum hoist and rubber tired backhoe

GROUP 16: Forklift and 1 drum hoist

GROUP 17: Compressor or welder operator

GROUP 18: Oiler

\* ENGI0324-004 06/01/2021

AREA 1: ALLEGAN, BARRY, BERRIEN, BRANCH, CALHOUN, CASS, EATON, HILLSDALE, IONIA, KALAMAZOO, KENT, LAKE, MANISTEE, MASON, MECOSTA, MONTCALM, MUSKEGON, NEWAYGO, OCEANA, OSCEOLA, OTTAWA, ST. JOSEPH, VAN BUREN

AREA 2: ANTRIM, BENZIE, CHARLEVOIX, EMMET, GRAND TRAVERSE, KALKASKA, LEELANAU, MISSAUKEE AND WEXFORD COUNTIES:

Rates Fringes

OPERATOR: Power Equipment (Steel Erection)

AREA 1

GROUP 1.....	\$ 48.02	24.85
GROUP 2.....	\$ 44.75	24.85
GROUP 3.....	\$ 43.21	24.85
GROUP 4.....	\$ 39.37	24.85
GROUP 5.....	\$ 24.89	12.00
GROUP 6.....	\$ 28.38	12.00

AREA 2

GROUP 1.....	\$ 48.02	24.85
GROUP 2.....	\$ 44.75	24.85
GROUP 3.....	\$ 43.21	24.85
GROUP 4.....	\$ 39.37	24.85
GROUP 5.....	\$ 24.89	12.00
GROUP 6.....	\$ 28.38	12.00

FOOTNOTES:

Crane operator with main boom and jib 300' or longer: \$1.50 additional to the group 1 rate. Crane operator with main boom and jib 400' or longer: \$3.00 additional to the group 1 rate.

PAID HOLIDAYS: New Year's Day, Memorial Day, Fourth of July, Labor Day, Thanksgiving Day and Christmas Day.

POWER EQUIPMENT OPERATOR CLASSIFICATIONS:

GROUP 1: Crane Operator with main boom & jib 400', 300', or 220' or longer.

GROUP 2: Crane Operator with main boom & jib 140' or longer, Tower Crane; Gantry Crane; Whirley Derrick.

GROUP 3: Regular Equipment Operator, Crane, Dozer, Loader, Hoist, Straddle Wagon, Mechanic, Grader and Hydro Excavator.

GROUP 4: Air Tugger (single drum), Material Hoist Pump 6" or over, Elevators, Brokk Concrete Breaker.

GROUP 5: Air Compressor, Welder, Generators, Conveyors

GROUP 6: Oiler and fire tender

ENGI0324-005 09/01/2020

AREA 1: GENESEE, LAPEER, LIVINGSTON, MACOMB, MONROE, OAKLAND, ST. CLAIR, WASHTENAW AND WAYNE COUNTIES

AREA 2: ALCONA, ALLEGAN, ALGER, ALPENA, ANTRIM, ARENAC, BARAGA, BARRY, BAY, BENZIE, BERRIEN, BRANCH, CALHOUN, CASS, CHARLEVOIX, CHEBOYGAN, CHIPPEWA, CLARE, CLINTON, CRAWFORD, DELTA, DICKINSON, EATON, EMMET, GLADWIN, GOGEBIC, GRAND TRAVERSE, GRATIOT, HILLSDALE, HOUGHTON, HURON, INGHAM, IONIA, IOSCO, IRON, ISABELLA, JACKSON, KALAMAZOO, KALKASKA, KENT, KWEENAW, LAKE, LEELANAU, LENAWEE, LUCE, MACKINAC, MANISTEE, MARQUETTE, MASON, MECOSTA, MENOMINEE, MIDLAND, MISSAUKEE, MONTCALM, MONTMORENCY, MUSKEGON, NEWAYGO, OCEANA, OGEMAW, ONTONAGON, OSCEOLA, OSCODA, OTSEGO, OTTAWA, PRESQUE ISLE, ROSCOMMON, SAGINAW, SANILAC, SCHOOLCRAFT, SHIAWASSEE, ST. JOSEPH, TUSCOLA, VAN BUREN AND WEXFORD COUNTIES

Rates Fringes

OPERATOR: Power Equipment  
(Underground construction  
(including sewer))

AREA 1:

GROUP 1.....	\$ 35.88	24.85
GROUP 2.....	\$ 31.15	24.85
GROUP 3.....	\$ 30.42	24.85
GROUP 4.....	\$ 29.85	24.85
GROUP 5.....	\$ 21.40	12.05

AREA 2:

GROUP 1.....	\$ 34.17	24.85
GROUP 2.....	\$ 29.28	24.85
GROUP 3.....	\$ 28.78	24.85
GROUP 4.....	\$ 28.50	24.85
GROUP 5.....	\$ 21.40	12.05

POWER EQUIPMENT OPERATOR CLASSIFICATIONS

GROUP 1: Backfiller tamper; Backhoe; Batch plant operator (concrete); Clamshell; Concrete paver (2 drums or larger); Conveyor loader (Euclid type); Crane (crawler, truck type or pile driving); Dozer; Dragline; Elevating grader; Endloader; Gradall (and similar type machine); Grader; Mechanic; Power shovel; Roller (asphalt); Scraper (self-propelled or tractor drawn); Side boom tractor (type D-4 or equivalent and larger); Slip form paver; Slope paver; Trencher (over 8 ft. digging capacity); Well drilling rig; Concrete pump with boom operator; Hydro Excavator

GROUP 2: Boom truck (power swing type boom); Crusher; Hoist; Pump (1 or more - 6-in. discharge or larger - gas or diesel- powered or powered by generator of 300 amperes or more - inclusive of generator); Side boom tractor (smaller than type D-4 or equivalent); Tractor (pneu-tired, other than backhoe or front end loader); Trencher (8-ft. digging capacity and smaller); Vac Truck and End dump operator;

GROUP 3: Air compressors (600 cfm or larger); Air compressors (2 or more-less than 600 cfm); Boom truck (non-swinging, non- powered type boom); Concrete breaker (self-propelled or truck mounted - includes compressor); Concrete paver (1 drum-1/2 yd. or larger); Elevator (other than passenger); Maintenance person; Pump (2 or more-4-in. up to 6-in. discharge-gas or diesel powered - excluding submersible

pumps); Pumpcrete machine (and similar equipment); Wagon drill (multiple); Welding machine or generator (2 or more-300 amp. or larger - gas or diesel powered)

GROUP 4: Boiler; Concrete saw (40 hp or over); Curing machine (self-propelled); Farm tractor (with attachment); Finishing machine (concrete); Hydraulic pipe pushing machine; Mulching equipment; Pumps (2 or more up to 4-in. discharge, if used 3 hours or more a day, gas or diesel powered - excluding submersible pumps); Roller (other than asphalt); Stump remover; Trencher (service); Vibrating compaction equipment, self-propelled (6 ft. wide or over); Sweeper (Wayne type); Water wagon and Extend-a boom forklift

Group 5: Fire Person, Oiler

-----  
 \* ENGI0324-006 06/01/2021

GENESEE, MACOMB, MONROE, OAKLAND, WASHTENAW, WAYNE, ALCONA, ALGER, ALLEGAN, ALPENA, ANTRIM, ARENAC, BARAGA, BARRY, BAY, BENZIE, BERRIEN, BRANCH, CALHOUN, CASS, CHARLEVOIX, CHEBOYGAN, CHIPPEWA, CLARE, CLINTON, CRAWFORD, DELTA, DICKINSON, EATON, EMMET, GLADWIN, GOGEBIC, GRAND TRAVERSE, GRATIOT, HILLSDALE, HOUGHTON, HURON, INGHAM, IONIA, IOSCO, IRON, ISABELLA, JACKSON, KALAMAZOO, KALKASKA, KENT, KEWEENAW, LAKE, LAPEER, LEELANAU, LENAWEE, LIVINGSTON, LUCE, MACKINAC, MANISTEE, MARQUETTE, MASON, MECOSTA, MENOMINEE, MIDLAND, MISSAUKEE, MONTCALM, MONTMORENCY, MUSKEGON, NEWAYGO, OCEANA, OGEMAW, ONTONAGON, OSCEOLA, OSCODA, OTSEGO, OTTAWA, PRESQUE ISLE, ROSCOMMON, SAGINAW, ST. CLARE, ST. JOSEPH, SANILAC, SCHOOLCRAFT, SHIAWASSEE, TUSCOLA, VAN BUREN AND WEXFORD COUNTIES

Rates      Fringes

Power equipment operators:

(AIRPORT, BRIDGE & HIGHWAY CONSTRUCTION)

GROUP 1.....	\$ 36.86	24.85
GROUP 2.....	\$ 30.13	24.85
GROUP 3.....	\$ 29.52	24.85
GROUP 4.....	\$ 29.40	24.85

POWER EQUIPMENT OPERATOR CLASSIFICATIONS

GROUP 1: Asphalt plant operator; Crane operator (does not include work on bridge construction projects when the crane operator is erecting structural components); Dragline operator; Shovel operator; Locomotive operator; Paver operator (5 bags or more); Elevating grader operator; Pile driving operator; Roller operator (asphalt); Blade grader operator; Trenching machine operator (ladder or wheel type); Auto-grader; Slip form paver; Self-propelled or tractor-drawn scraper; Conveyor loader operator (Euclid type); Endloader operator (1 yd. capacity and over); Bulldozer; Hoisting engineer; Tractor operator; Finishing machine operator (asphalt); Mechanic; Pump operator (6-in. discharge or over, gas, diesel powered or generator of 300 amp. or larger); Shouldering or gravel distributing machine operator (self- propelled); Backhoe (with over 3/8 yd. bucket); Side boom tractor (type D-4 or equivalent or larger); Tube finisher (slip form paving); Gradall (and similar type machine); Asphalt paver (self- propelled);

Asphalt planer (self-propelled); Batch plant (concrete-central mix); Slurry machine (asphalt); Concrete pump (3 in. and over); Roto-mill; Swinging boom truck (over 12 ton capacity); Hydro demolisher (water blaster); Farm-type tractor with attached pan; Vacuum truck operator; Batch Plant (concrete dry batch); Concrete Saw Operator (40h.p. or over; Tractor Operator (farm type); Finishing Machine Operator (concrete); Grader Operator (self-propelled fine grade or form (concrete)).

GROUP 2: Screening plant operator; Washing plant operator; Crusher operator; Backhoe (with 3/8 yd. bucket or less); Side boom tractor (smaller than D-4 type or equivalent); Sweeper (Wayne type and similar equipment); Greese Truck; Air Compressor Operator (600 cu.ft. per min or more); Air Compressor Operator (two or more, less than 600 cfm);

GROUP 3: Boiler fire tender; Tractor operator (farm type with attachment); Concrete Breaker; Wagon Drill Operator;

GROUP 4: Oiler; Fire tender; Trencher (service); Flexplane operator; Cleftplane operator; Boom or winch hoist truck operator; Endloader operator \*under 1 yd. capacity); Roller Operator (other than asphalt); Curing equipment operator (self-propelled); Power bin operator; Plant drier (6 ft. wide or over); Guard post driver operator (power driven); All mulching equipment; Stump remover; Concrete pump (under 3-in.); Mesh installer (self-propelled); End dump; Skid Steer.

-----  
 ENGI0324-007 05/01/2020

ALGER, BARAGA, CHIPPEWA, DELTA, DICKINSON, GOGEBIC, HOUGHTON, IRON, KEWEENAW, LUCE, MACKINAC MARQUETTE, MENOMINEE, ONTONAGON AND SCHOOLCRAFT COUNTIES:

Rates Fringes

OPERATOR: Power Equipment  
 (Steel Erection)

Compressor, welder and forklift.....	\$ 33.90	24.60
Crane operator, main boom & jib 120' or longer.....	\$ 40.37	24.60
Crane operator, main boom & jib 140' or longer.....	\$ 40.67	24.60
Crane operator, main boom & jib 220' or longer.....	\$ 41.26	24.60
Mechanic with truck and tools.....	\$ 39.50	24.60
Oiler and fireman.....	\$ 32.36	24.60
Regular operator.....	\$ 37.72	24.60

-----  
 ENGI0324-008 10/01/2020

ALCONA, ALGER, ALLEGAN, ALPENA, ANTRIM, ARENAC, BARAGA, BARRY, BAY, BENZIE, BERRIEN, BRANCH, CALHOUN, CASS, CHARLEVOIX, CHEBOYGAN, CHIPPEWA, CLARE, CLINTON, CRAWFORD, DELTA, DICKINSON, EATON, EMMET, GENESEE, GLADWIN, GOGEBIC, GRAND TRAVERSE, GRATIOT, HILLSDALE, HOUGHTON, HURON, INGHAM, IONIA, IOSCO, IRON, ISABELLA, JACKSON, KALAMAZOO, KALKASKA, KENT, KEWEENAW, LAKE, LAPEER, LEELANAU, LENAWEE, LIVINGSTON, LUCE,

MACKINAC, MACOMB, MANISTEE, MARQUETTE, MASON, MECOSTA, MENOMINEE, MIDLAND, MISSAUKEE, MONTCALM, MONTMORENCY, MONROE, MUSKEGON, NEWAYGO, OAKLAND, OCEANA, OGEMAW, ONTONAGON, OSCEOLA, OSCODA, OTSEGO, OTTAWA, PRESQUE ISLE, ROSCOMMON, SAGINAW, ST. CLARE, ST. JOSEPH, SANILAC, SCHOOLCRAFT, SHIAWASSEE, TUSCOLA, VAN BUREN, WASHTENAW, WAYNE AND WEXFORD COUNTIES

Rates Fringes

OPERATOR: Power Equipment  
(Sewer Relining)

GROUP 1.....	\$ 34.62	13.92
GROUP 2.....	\$ 32.83	13.92

SEWER RELINING CLASSIFICATIONS

GROUP 1: Operation of audio-visual closed circuit TV system, including remote in-ground cutter and other equipment used in connection with the CCTV system

GROUP 2: Operation of hot water heaters and circulation systems, water jettors and vacuum and mechanical debris removal systems

-----  
ENGI0325-012 05/01/2021

Rates Fringes

Power equipment operators -  
gas distribution and duct  
installation work:

GROUP 1.....	\$ 33.48	24.85
GROUP 2.....	\$ 31.45	24.85
GROUP 3.....	\$ 30.35	24.85

SCOPE OF WORK: The construction, installation, treating and reconditioning of pipelines transporting gas vapors within cities, towns, subdivisions, suburban areas, or within private property boundaries, up to and including private meter settings of private industrial, governmental or other premises, more commonly referred to as "distribution work," starting from the first metering station, connection, similar or related facility, of the main or cross country pipeline and including duct installation.

Group 1: Backhoe, crane, grader, mechanic, dozer (D-6 equivalent or larger), side boom (D-4 equivalent or larger), trencher(except service), endloader (2 yd. capacity or greater).

GROUP 2: Dozer (less than D-6 equivalent), endloader (under 2 yd. capacity), side boom (under D-4 capacity), backfiller, pumps (1 or 2 of 6-inch discharge or greater), boom truck (with powered boom), tractor (wheel type other than backhoe or front endloader). Tamper (self-propelled), boom truck (with non-powered boom), concrete saw (20 hp or larger), pumps (2 to 4 under 6-inch discharge), compressor (2 or more or when one is used continuously into the second day) and trencher(service).

GROUP 3: Oiler, hydraulic pipe pushing machine, grease person and hydrostatic testing operator.

-----  
 IRON0008-007 06/01/2021

ALGER, BARAGA, CHIPPEWA, DELTA, DICKINSON, GOGEBIC, HOUGHTON,  
 IRON, KEWEENAW, LUCE, MACKINAC MARQUETTE, MENOMINEE, ONTONAGON  
 AND SCHOOLCRAFT COUNTIES:

	Rates	Fringes
Ironworker - pre-engineered metal building erector.....	\$ 23.70	6.95
IRONWORKER		
General contracts \$10,000,000 or greater.....	\$ 36.45	27.65
General contracts less than \$10,000,000.....	\$ 36.45	27.65

Paid Holidays: New Year's Day, Memorial Day, July 4th, Labor  
 Day, Thanksgiving Day & Christmas Day.

-----  
 IRON0025-002 06/01/2019

ALCONA, ALPENA, ARENAC, BAY, CHEBOYGAN, CLARE, CLINTON,  
 CRAWFORD, GENESEE, GLADWIN, GRATIOT, HURON, INGHAM, IOSCO,  
 ISABELLA, JACKSON, LAPEER, LIVINGSTON, MACOMB, MIDLAND,  
 MONTMORENCY, OAKLAND, OGEMAW, OSCODA, OTSEGO, PRESQUE ISLE,  
 ROSCOMMON, SAGINAW, SANILAC, SHIAWASSEE, ST. CLAIR, TUSCOLA,  
 WASHTENAW AND WAYNE COUNTIES:

	Rates	Fringes
Ironworker - pre-engineered metal building erector Alcona, Alpena, Arenac, Cheboygan, Clare, Clinton, Crawford, Gladwin, Gratiot, Huron, Ingham, Iosco, Isabella, Jackson, Lapeer, Livingston (west of Burkhardt Road), Montmorency, Ogemaw, Oscoda, Otsego, Presque Isle, Roscommon, Sanilac, Shiawassee, Tuscola & Washtenaw (west of U.S. 23).	\$ 24.26	22.11
Bay, Genesee, Lapeer, Livingston (east of Burkhardt Road), Macomb, Midland, Oakland, Saginaw, St. Clair, The University of Michigan, Washtenaw (east of U.S. 23) & Wayne...	\$ 25.48	23.11
IRONWORKER		
Ornamental and Structural...	\$ 36.77	29.03
Reinforcing.....	\$ 30.98	27.99

-----  
 IRON0055-005 07/01/2021

LENAWEE AND MONROE COUNTIES:

Rates	Fringes
-------	---------

IRONWORKER

Pre-engineered metal buildings.....	\$ 23.59	19.35
All other work.....	\$ 31.25	26.90

-----  
IRON0292-003 06/01/2020

BERRIEN AND CASS COUNTIES:

Rates Fringes

IRONWORKER (Including pre-engineered metal building erector).....	\$ 31.75	22.84
---	----------	-------

-----  
IRON0340-001 06/19/2017

ALLEGAN, ANTRIM, BARRY, BENZIE, BRANCH, CALHOUN, CHARLEVOIX, EATON, EMMET, GRAND TRAVERSE, HILLSDALE, IONIA, KALAMAZOO, KALKASKA, KENT, LAKE, LEELANAU, MANISTEE, MASON, MECOSTA, MISSAUKEE, MONTCALM, MUSKEGON, NEWAYGO, OCEANA, OSCEOLA, OTTAWA, ST. JOSEPH, VAN BUREN AND WEXFORD COUNTIES:

Rates Fringes

IRONWORKER (Including pre-engineered metal building erector).....	\$ 24.43	24.67
---	----------	-------

-----  
LABO0005-006 10/01/2020

Rates Fringes

Laborers - hazardous waste abatement: (ALCONA, ALPENA, ANTRIM, BENZIE, CHARLEVOIX, CHEBOYGAN, CRAWFORD, EMMET, GRAND TRAVERSE, IOSCO, KALKASKA, LEELANAU, MISSAUKEE, MONTMORENCY, OSCODA, OTSEGO, PRESQUE ISLE AND WEXFORD COUNTIES - Zone 10)

Levels A, B or C.....	\$ 17.45	12.75
class b.....	\$ 18.64	12.90
Work performed in conjunction with site preparation not requiring the use of personal protective equipment;		
Also, Level D.....	\$ 16.45	12.75
class a.....	\$ 17.64	12.90

Zone 10

Laborers - hazardous waste abatement: (ALGER, BARAGA, CHIPPEWA, DELTA, DICKINSON, GOGEBIC, HOUGHTON, IRON, KEWEENAW, LUCE, MACKINAC, MARQUETTE, MENOMINEE, ONTONAGON AND SCHOOLCRAFT COUNTIES - Zone 11)

Levels A, B or C.....	\$ 23.58	12.90
-----------------------	----------	-------

Work performed in conjunction with site preparation not requiring the use of personal protective equipment; Also, Level D.....\$ 22.58	12.90
Laborers - hazardous waste abatement: (ALLEGAN, BARRY, BERRIEN, BRANCH, CALHOUN, CASS, IONIA COUNTY (except the city of Portland); KALAMAZOO, KENT, LAKE, MANISTEE, MASON, MECOSTA, MONTCALM, MUSKEGON, NEWAYGO, OCEANA, OSCEOLA, OTTAWA, ST. JOSEPH AND VAN BUREN COUNTIES - Zone 9)	
Levels A, B or C.....\$ 21.80	12.90
Work performed in conjunction with site preparation not requiring the use of personal protective equipment; Also, Level D.....\$ 20.80	12.90
Laborers - hazardous waste abatement: (ARENAC, BAY, CLARE, GLADWIN, GRATIOT, HURON, ISABELLA, MIDLAND, OGEMAW, ROSCOMMON, SAGINAW AND TUSCOLA COUNTIES - Zone 8)	
Levels A, B or C.....\$ 21.39	12.90
Work performed in conjunction with site preparation not requiring the use of personal protective equipment; Also, Level D.....\$ 20.80	12.90
Laborers - hazardous waste abatement: (CLINTON, EATON AND INGHAM COUNTIES; IONIA COUNTY (City of Portland); LIVINGSTON COUNTY (west of Oak Grove Rd., including the City of Howell) - Zone 6)	
Levels A, B or C.....\$ 25.64	12.90
Work performed in conjunction with site preparation not requiring the use of personal protective equipment; Also, Level D.....\$ 24.64	12.90
Laborers - hazardous waste abatement: (GENESEE, LAPEER AND SHIAWASSEE COUNTIES - Zone 7)	
Levels A, B or C.....\$ 24.20	13.80
Work performed in conjunction with site preparation not requiring the use of personal protective equipment; Also, Level D.....\$ 23.20	13.80
Laborers - hazardous waste	

abatement: (HILLSDALE,  
JACKSON AND LENAWEЕ COUNTIES  
- Zone 4)

Levels A, B or C.....\$ 25.17      12.90

Work performed in  
conjunction with site  
preparation not requiring  
the use of personal  
protective equipment;

Also, Level D.....\$ 24.17      12.90

Laborers - hazardous waste  
abatement: (LIVINGSTON COUNTY  
(east of Oak Grove Rd. and  
south of M-59, excluding the  
city of Howell); AND  
WASHTENAW COUNTY - Zone 3)

Levels A, B or C.....\$ 29.93      14.20

Work performed in  
conjunction with site  
preparation not requiring  
the use of personal  
protective equipment;

Also, Level D.....\$ 28.93      14.20

Laborers - hazardous waste  
abatement: (MACOMB AND WAYNE  
COUNTIES - Zone 1)

Levels A, B or C.....\$ 29.93      16.90

Work performed in  
conjunction with site  
preparation not requiring  
the use of personal  
protective equipment;

Also, Level D.....\$ 28.93      16.90

Laborers - hazardous waste  
abatement: (MONROE COUNTY -  
Zone 4)

Levels A, B or C.....\$ 31.75      14.90

Work performed in  
conjunction with site  
preparation not requiring  
the use of personal  
protective equipment;

Also, Level D.....\$ 31.75      14.90

Laborers - hazardous waste  
abatement: (OAKLAND COUNTY  
and the Northeast portion of  
LIVINGSTON COUNTY bordered by  
Oak Grove Road on the West  
and M-59 on the South - Zone  
2)

Level A, B, C.....\$ 29.93      16.90

Work performed in  
conjunction with site  
preparation not requiring  
the use of personal  
protective equipment;

Also, Level D.....\$ 28.93      16.90

Laborers - hazardous waste  
abatement: (SANILAC AND ST.  
CLAIR COUNTIES - Zone 5)

Levels A, B or C.....\$ 25.75      16.35

Work performed in  
conjunction with site

preparation not requiring  
 the use of personal  
 protective equipment;  
 Also, Level D.....\$ 24.75      16.35

LABO0259-001 09/01/2018

AREA 1: MACOMB, OAKLAND AND WAYNE COUNTIES  
 AREA 2: ALCONA, ALGER, ALLEGAN, ALPENA, ANTRIM, ARENAC, BARAGA,  
 BARRY, BAY, BENZIE, BERRIEN, BRANCH, CALHOUN, CASS, CHARLEVOIX,  
 CHEBOYGAN, CHIPPEWA, CLARE, CLINTON, CRAWFORD, DELTA,  
 DICKINSON, EATON, EMMET, GENESEE, GLADWIN, GOGEBIC, GRAND  
 TRAVERSE, GRATIOT, HILLSDALE, HOUGHTON, HURON, INGHAM, IONIA,  
 IOSCO, IRON, ISABELLA, JACKSON, KALAMAZOO, KALKASKA, KENT,  
 KEWEENAW, LAKE, LAPEER, LEELANAU, LENAWEE, LIVINGSTON, LUCE,  
 MACKINAC, MANISTEE, MARQUETTE, MASON, MECOSTA, MENOMINEE,  
 MIDLAND, MISSAUKEE, MONROE, MONTCALM, MONTMORENCY, MUSKEGON,  
 NEWAYGO, OCEANA, OGEMAW, ONTONAGON, OSCEOLA, OSCODA, OTSEGO,  
 OTTAWA, PRESQUE ISLE, ROSCOMMON, SAGINAW, ST. CLARE, ST.  
 JOSEPH, SANILAC, SCHOOLCRAFT, SHIAWASSEE, TUSCOLA, VAN BUREN,  
 WASHTENAW AND WEXFORD COUNTIES

Rates      Fringes

Laborers - tunnel, shaft and  
 caisson:

AREA 1		
GROUP 1.....	\$ 22.57	16.80
GROUP 2.....	\$ 22.68	16.80
GROUP 3.....	\$ 22.74	16.80
GROUP 4.....	\$ 22.92	16.80
GROUP 5.....	\$ 23.17	16.80
GROUP 6.....	\$ 23.50	16.80
GROUP 7.....	\$ 16.78	16.80
AREA 2		
GROUP 1.....	\$ 24.10	12.85
GROUP 2.....	\$ 24.19	12.85
GROUP 3.....	\$ 24.29	12.85
GROUP 4.....	\$ 24.45	12.85
GROUP 5.....	\$ 24.71	12.85
GROUP 6.....	\$ 25.02	12.85
GROUP 7.....	\$ 17.29	12.85

SCOPE OF WORK: Tunnel, shaft and caisson work of every type  
 and description and all operations incidental thereto,  
 including, but not limited to, shafts and tunnels for  
 sewers, water, subways, transportation, diversion,  
 sewerage, caverns, shelters, aquifers, reservoirs, missile  
 silos and steel sheeting for underground construction.

TUNNEL LABORER CLASSIFICATIONS

GROUP 1: Tunnel, shaft and caisson laborer, dump, shanty, hog  
 house tender, testing (on gas) and watchman

GROUP 2: Manhole, headwall, catch basin builder, bricklayer  
 tender, mortar machine and material mixer

GROUP 3: Air tool operator (jackhammer, bush hammer and  
 grinder), first bottom, second bottom, cage tender, car  
 pusher, carrier, concrete, concrete form, concrete repair,  
 cement invert laborer, cement finisher, concrete shoveler,  
 conveyer, floor, gasoline and electric tool operator,

gunitite, grout operator, welder, heading dinky person, inside lock tender, pea gravel operator, pump, outside lock tender, scaffold, top signal person, switch person, track, tugger, utility person, vibrator, winch operator, pipe jacking, wagon drill and air track operator and concrete saw operator (under 40 h.p.)

GROUP 4: Tunnel, shaft and caisson mucker, bracer, liner plate, long haul dinky driver and well point

GROUP 5: Tunnel, shaft and caisson miner, drill runner, key board operator, power knife operator, reinforced steel or mesh (e.g. wire mesh, steel mats, dowel bars, etc.)

GROUP 6: Dynamite and powder

GROUP 7: Restoration laborer, seeding, sodding, planting, cutting, mulching and top soil grading; and the restoration of property such as replacing mailboxes, wood chips, planter boxes, flagstones, etc.

-----  
LABO0334-001 09/01/2018

Rates      Fringes

Laborers - open cut:

ZONE 1 - MACOMB, OAKLAND AND WAYNE COUNTIES:

GROUP 1.....	\$ 22.42	16.80
GROUP 2.....	\$ 22.53	16.80
GROUP 3.....	\$ 22.58	16.80
GROUP 4.....	\$ 22.66	16.80
GROUP 5.....	\$ 22.72	16.80
GROUP 6.....	\$ 20.17	16.80
GROUP 7.....	\$ 16.79	16.80

ZONE 2 - LIVINGSTON COUNTY

(east of M-151 (Oak Grove Rd.)); MONROE AND

WASHTENAW COUNTIES:

GROUP 1.....	\$ 23.75	12.85
GROUP 2.....	\$ 23.86	12.85
GROUP 3.....	\$ 23.98	12.85
GROUP 4.....	\$ 24.05	12.85
GROUP 5.....	\$ 24.20	12.85
GROUP 6.....	\$ 21.50	12.85
GROUP 7.....	\$ 18.14	12.85

ZONE 3 - CLINTON, EATON, GENESEE, HILLSDALE AND INGHAM COUNTIES; IONIA

COUNTY (City of Portland);

JACKSON, LAPEER AND

LENAWEE COUNTIES;

LIVINGSTON COUNTY (west of

M-151 Oak Grove Rd.);

SANILAC, ST. CLAIR AND

SHIAWASSEE COUNTIES:

GROUP 1.....	\$ 21.94	12.85
GROUP 2.....	\$ 22.08	12.85
GROUP 3.....	\$ 22.20	12.85
GROUP 4.....	\$ 22.25	12.85
GROUP 5.....	\$ 22.39	12.85
GROUP 6.....	\$ 19.69	12.85

GROUP 7.....	\$ 16.84	12.85
ZONE 4 - ALCONA, ALLEGAN, ALPENA, ANTRIM, ARENAC, BARRY, BAY, BENZIE, BERRIEN, BRANCH, CALHOUN, CASS, CHARLEVOIX, CHEBOYGAN, CLARE, CRAWFORD, EMMET, GLADWIN, GRAND TRAVERSE, GRATIOT AND HURON COUNTIES; IONIA COUNTY (EXCEPT THE CITY OF PORTLAND); IOSCO, ISABELLA, KALAMAZOO, KALKASKA, KENT, LAKE,LEELANAU, MANISTEE, MASON, MECOSTA, MIDLAND, MISSAUKEE, MONTCALM, MONTMORENCY, MUSKEGON, NEWAYGO, OCEANA, OGEMAW, OSCEOLA, OSCODA, OTSEGO, OTTAWA, PRESQUE ISLE, ROSCOMMON, SAGINAW, ST. JOSEPH, TUSCOLA, VAN BUREN AND WEXFORD COUNTIES:		
GROUP 1.....	\$ 20.97	12.85
GROUP 2.....	\$ 21.10	12.85
GROUP 3.....	\$ 21.21	12.85
GROUP 4.....	\$ 21.28	12.85
GROUP 5.....	\$ 21.40	12.85
GROUP 6.....	\$ 18.62	12.85
GROUP 7.....	\$ 16.96	12.85
ZONE 5 - ALGER, BARAGA, CHIPPEWA, DELTA, DICKINSON, GOGEBIC, HOUGHTON, IRON, KEWEENAW, LUCE, MACKINAC, MARQUETTE, MENOMINEE, ONTONAGON AND SCHOOLCRAFT COUNTIES:		
GROUP 1.....	\$ 21.19	12.85
GROUP 2.....	\$ 21.33	12.85
GROUP 3.....	\$ 21.46	12.85
GROUP 4.....	\$ 21.51	12.85
GROUP 5.....	\$ 21.56	12.85
GROUP 6.....	\$ 18.94	12.85
GROUP 7.....	\$ 17.05	12.85

SCOPE OF WORK:

Open cut construction work shall be construed to mean work which requires the excavation of earth including industrial, commercial and residential building site excavation and preparation, land balancing, demolition and removal of concrete and underground appurtenances, grading, paving, sewers, utilities and improvements; retention, oxidation, flocculation and irrigation facilities, and also including but not limited to underground piping, conduits, steel sheeting for underground construction, and all work incidental thereto, and general excavation. For all areas except the Upper Peninsula, open cut construction work shall also be construed to mean waterfront work, piers, docks, seawalls, breakwalls, marinas and all incidental

work. Open cut construction work shall not include any structural modifications, alterations, additions and repairs to buildings, or highway work, including roads, streets, bridge construction and parking lots or steel erection work and excavation for the building itself and back filling inside of and within 5 ft. of the building and foundations, footings and piers for the building. Open cut construction work shall not include any work covered under Tunnel, Shaft and Caisson work.

#### OPEN CUT LABORER CLASSIFICATIONS

##### GROUP 1: Construction laborer

GROUP 2: Mortar and material mixer, concrete form person, signal person, well point person, manhole, headwall and catch basin builder, headwall, seawall, breakwall and dock builder

GROUP 3: Air, gasoline and electric tool operator, vibrator operator, driller, pump person, tar kettle operator, bracer, rodder, reinforced steel or mesh person (e.g., wire mesh, steel mats, dowel bars, etc.), welder, pipe jacking and boring person, wagon drill and air track operator and concrete saw operator (under 40 h.p.), windlass and tugger person and directional boring person

##### GROUP 4: Trench or excavating grade person

GROUP 5: Pipe layer (including crock, metal pipe, multi-plate or other conduits)

GROUP 6: Grouting man, audio-visual television operations and all other operations in connection with closed circuit television inspection, pipe cleaning and pipe relining work and the installation and repair of water service pipe and appurtenances

GROUP 7: Restoration laborer, seeding, sodding, planting, cutting, mulching and top soil grading; and the restoration of property such as replacing mailboxes, wood chips, planter boxes, flagstones, etc.

-----  
LABO0465-001 06/01/2020

LABORER: Highway, Bridge and Airport Construction

AREA 1: GENESEE, MACOMB, MONROE, OAKLAND, WASHTENAW AND WAYNE COUNTIES

AREA 2: ALLEGAN, BARRY, BAY, BERRIEN, BRANCH, CALHOUN, CASS, CLINTON, EATON, GRATIOT, HILLSDALE, HURON, INGHAM, JACKSON, KALAMAZOO, LAPEER, LENAWEE, LIVINGSTON, MIDLAND, MUSKEGON, SAGINAW, SANILAC, SHIAWASSEE, ST. CLAIR, ST. JOSEPH, TUSCOLA AND VAN BUREN COUNTIES

AREA 3: ALCONA, ALPENA, ANTRIM, ARENAC, BENZIE, CHARLEVOIX, CHEBOYGAN, CLARE, CRAWFORD, EMMET, GLADWIN, GRAND TRAVERSE, IONIA, IOSCO, ISABELLA, KALKASKA, KENT, LAKE, LEELANAU, MANISTEE, MASON, MECOSTA, MISSAUKEE, MONTCALM, MONTMORENCY, NEWAYGO, OCEANA, OGEMAW, OSCEOLA, OSCODA, OTSEGO, OTTAWA, PRESQUE ISLE, ROSCOMMON AND WEXFORD COUNTIES

AREA 4: ALGER, BARAGA, CHIPPEWA, DELTA, DICKINSON, GOGEBIC, HOUGHTON, IRON, KEWEENAW, LUCE, MACKINAC, MARQUETTE, MENOMINEE, ONTONAGON AND SCHOOLCRAFT COUNTIES

	Rates	Fringes
LABORER (AREA 1)		
GROUP 1.....	\$ 26.22	12.90
GROUP 2.....	\$ 26.43	12.90
GROUP 3.....	\$ 26.72	12.90
GROUP 4.....	\$ 27.16	12.90
GROUP 5.....	\$ 26.78	12.90
GROUP 6.....	\$ 27.21	12.90
LABORER (AREA 2)		
GROUP 1.....	\$ 26.92	12.90
GROUP 2.....	\$ 27.12	12.90
GROUP 3.....	\$ 27.36	12.90
GROUP 4.....	\$ 27.71	12.90
GROUP 5.....	\$ 27.58	12.90
GROUP 6.....	\$ 27.92	12.90
LABORER (AREA 3)		
GROUP 1.....	\$ 26.22	12.90
GROUP 2.....	\$ 26.43	12.90
GROUP 3.....	\$ 26.72	12.90
GROUP 4.....	\$ 27.16	12.90
GROUP 5.....	\$ 26.78	12.90
GROUP 6.....	\$ 27.21	12.90
LABORER (AREA 4)		
GROUP 1.....	\$ 26.22	12.90
GROUP 2.....	\$ 26.43	12.90
GROUP 3.....	\$ 26.72	12.90
GROUP 4.....	\$ 27.16	12.90
GROUP 5.....	\$ 26.78	12.90
GROUP 6.....	\$ 27.21	12.90

LABORER CLASSIFICATIONS

GROUP 1: Asphalt shoveler or loader; asphalt plant misc.; burlap person; yard person; dumper (wagon, truck, etc.); joint filling laborer; miscellaneous laborer; unskilled laborer; sprinkler laborer; form setting laborer; form stripper; pavement reinforcing; handling and placing (e.g., wire mesh, steel mats, dowel bars); mason's tender or bricklayer's tender on manholes; manhole builder; headwalls, etc.; waterproofing,(other than buildings) seal coating and slurry mix, shoring, underpinning; pressure grouting; bridge pin and hanger removal; material recycling laborer; horizontal paver laborer (brick, concrete, clay, stone and asphalt); ground stabilization and modification laborer; grouting; waterblasting; top person; railroad track and trestle laborer; carpenters' tender; guard rail builders' tender; earth retention barrier and wall and M.S.E. wall installer's tender; highway and median installer's tender(including sound, retaining, and crash barriers); fence erector's tender; asphalt raker tender; sign installer; remote control operated equipment.

GROUP 2: Mixer operator (less than 5 sacks); air or electric tool operator (jackhammer, etc.); spreader; boxperson (asphalt, stone, gravel); concrete paddler; power chain saw operator; paving batch truck dumper; tunnel mucker (highway work only); concrete saw (under 40 h.p.) and dry pack

machine; roto-mill grounds person.

GROUP 3: Tunnel miner (highway work only); finishers tenders; guard rail builders; highway and median barrier installer; earth retention barrier and wall and M.S.E. wall installer's (including sound, retaining and crash barriers); fence erector; bottom person; powder person; wagon drill and air track operator; diamond and core drills; grade checker; certified welders; curb and side rail setter's tender.

GROUP 4: Asphalt raker

GROUP 5: Pipe layers, oxy-gun

GROUP 6: Line-form setter for curb or pavement; asphalt screed checker/screw man on asphalt paving machines.

LABO1076-005 04/01/2021

MICHIGAN STATEWIDE

Rates Fringes

LABORER (DISTRIBUTION WORK)

Zone 1.....	\$ 23.92	12.95
Zone 2.....	\$ 22.22	12.95
Zone 3.....	\$ 20.35	12.95
Zone 4.....	\$ 19.77	12.95
Zone 5.....	\$ 19.75	12.95

DISTRIBUTION WORK - The construction, installation, treating and reconditioning of distribution pipelines transporting coal, oil, gas or other similar materials, vapors or liquids, including pipelines within private property boundaries, up to and including the meter settings on residential, commercial, industrial, institutional, private and public structures. All work covering pumping stations and tank farms not covered by the Building Trades Agreement. Other distribution lines with the exception of sewer, water and cable television are included.

Underground Duct Layer Pay: \$.40 per hour above the base pay rate.

- Zone 1 - Macomb, Oakland and Wayne
- Zone 2 - Monroe and Washtenaw
- Zone 3 - Bay, Genesee, Lapeer, Midland, Saginaw, Sanilac, Shiawassee and St. Clair
- Zone 4 - Alger, Baraga, Chippewa, Delta, Dickinson, Gogebic, Houghton, Iron, Keweenaw, Luce, Mackinac, Marquette, Menominee, Ontonagon and Schoolcraft
- Zone 5 - Remaining Counties in Michigan

PAIN0022-002 07/01/2008

HILLSDALE, JACKSON AND LENAWEE COUNTIES; LIVINGSTON COUNTY (east of the eastern city limits of Howell, not including the city of Howell, north to the Genesee County line and south to the Washtenaw County line); MACOMB, MONROE, OAKLAND, WASHTENAW AND WAYNE COUNTIES:

	Rates	Fringes
PAINTER.....	\$ 25.06	14.75

FOOTNOTES: For all spray work and journeyman rigging for spray work, also blowing off, \$0.80 per hour additional (applies only to workers doing rigging for spray work on off the floor work. Does not include setting up or moving rigging on floor surfaces, nor does it apply to workers engaged in covering up or tending spray equipment. For all sandblasting and spray work performed on highway bridges, overpasses, tanks or steel, \$0.80 per hour additional. For all brushing, cleaning and other preparatory work (other than spraying or steeplejack work) at scaffold heights of fifty (50) feet from the ground or higher, \$0.50 per hour additional. For all preparatorial work and painting performed on open steel under forty (40) feet when no scaffolding is involved, \$0.50 per hour additional. For all swing stage work-window jacks and window belts-exterior and interior, \$0.50 per hour additional. For all spray work and sandblaster work to a scaffold height of forty (40) feet above the floor level, \$0.80 per hour additional. For all preparatorial work and painting on all highway bridges or overpasses up to forty (40) feet in height, \$0.50 per hour additional. For all steeplejack work performed where the elevation is forty (40) feet or more, \$1.25 per hour additional.

-----  
PAIN0312-001 06/01/2018

EXCLUDES: ALLEGAN COUNTY (Townships of Dorr, Fillmore, Heath, Hopkins, Laketown, Leighton, Manlius, Monterey, Overisel, Salem, Saugatuck and Wayland); INCLUDES: Barry, Berrien, Branch, Calhoun, Cass, Hillsdale, Kalamazoo, St. Joseph, Van Buren

	Rates	Fringes
PAINTER		
Brush and roller.....	\$ 23.74	13.35
Spray, Sandblast, Sign Painting.....	\$ 24.94	13.35

-----  
PAIN0845-003 05/10/2018

CLINTON COUNTY; EATON COUNTY (does not include the townships of Bellevue and Olivet); INGHAM COUNTY; IONIA COUNTY (east of Hwy. M 66); LIVINGSTON COUNTY (west of the eastern city limits of Howell, including the city of Howell, north to the Genesee County line and south to the Washtenaw County line); AND SHIAWASSEE COUNTY (Townships of Bennington, Laingsbury and Perry):

	Rates	Fringes
PAINTER.....	\$ 25.49	13.74

-----  
PAIN0845-015 05/10/2018

MUSKEGON COUNTY; NEWAYGO COUNTY (except the Townships of

Barton, Big Prairie, Brooks, Croton, Ensley, Everett, Goodwell, Grant, Home, Monroe, Norwich and Wilcox); OCEANA COUNTY; OTTAWA COUNTY (except the townships of Allendale, Blendone, Chester, Georgetown, Holland, Jamestown, Olive, Park, Polkton, Port Sheldon, Tallmadge, Wright and Zeeland):

	Rates	Fringes
PAINTER.....	\$ 25.49	13.74

-----  
 PAIN0845-018 05/10/2018

ALLEGAN COUNTY (Townships of Dorr, Fillmore, Heath, Hopkins, Laketown, Leighton, Manlius, Monterey, Overisel, Salem, Saugatuck and Wayland); IONIA COUNTY (west of Hwy. M-66); KENT, MECOSTA AND MONTCALM COUNTIES; NEWAYGO COUNTY (Townships of Barton, Big Prairie, Brooks, Croton, Ensley, Everett, Goodwell, Grant, Home, Monroe, Norwich and Wilcox); OSCEOLA COUNTY (south of Hwy. #10); OTTAWA COUNTY (Townships of Allendale, Blendone, Chester, Georgetown, Holland, Jamestown, Olive, Park, Polkton, Port Sheldon, Tallmadge, Wright and Zeeland):

	Rates	Fringes
PAINTER.....	\$ 25.49	13.74

FOOTNOTES: Lead abatement work: \$1.00 per hour additional.

-----  
 PAIN1011-003 06/02/2021

ALGER, BARAGA, CHIPPEWA, DELTA, DICKINSON, GOGEBIC, HOUGHTON, IRON, KEWEENAW, LUCE, MACKINAC, MARQUETTE, MENOMINEE, ONTONAGON AND SCHOOLCRAFT COUNTIES:

	Rates	Fringes
PAINTER.....	\$ 26.71	14.38

FOOTNOTES: High pay (bridges, overpasses, watertower): 30 to 80 ft.: \$.65 per hour additional. 80 ft. and over: \$1.30 per hour additional.

-----  
 PAIN1474-002 06/01/2010

HURON COUNTY; LAPEER COUNTY (east of Hwy. M-53); ST. CLAIR, SANILAC AND TUSCOLA COUNTIES:

	Rates	Fringes
PAINTER.....	\$ 23.79	12.02

FOOTNOTES: Lead abatement work: \$1.00 per hour additional. Work with any hazardous material: \$1.00 per hour additional. Sandblasting, steam cleaning and acid cleaning: \$1.00 per hour additional. Ladder work at or above 40 ft., scaffold work at or above 40 ft., swing stage, boatswain chair, window jacks and all work performed over a falling height of 40 ft.: \$1.00 per hour additional. Spray gun work, pick pullers and those handling needles, blowing off by air pressure, and any person rigging (setting up and moving off the ground): \$1.00 per hour additional.

Steeplejack, tanks, gas holders, stacks, flag poles, radio towers and beacons, power line towers, bridges, etc.: \$1.00 per hour additional, paid from the ground up.

-----  
 PAIN1803-003 06/01/2019

ALCONA, ALPENA, ANTRIM, ARENAC, BAY, BENZIE, CHARLEVOIX, CHEBOYGAN, CLARE, CRAWFORD, EMMET, GLADWIN, GRAND TRAVERSE, GRATIOT, IOSCO, ISABELLA, KALKASKA, LAKE, LEELANAU, MANISTEE, MASON, MIDLAND, MISSAUKEE, MONTMORENCY AND OGEMAW COUNTIES; OSCEOLA COUNTY (north of Hwy. #10); OSCODA, OTSEGO, PRESQUE ISLE, ROSCOMMON, SAGINAW AND WEXFORD COUNTIES:

Rates Fringes

PAINTER

Work performed on water, bridges over water or moving traffic, radio and powerline towers, elevated tanks, steeples, smoke stacks over 40 ft. of falling heights, recovery of lead-based paints and any work associated with industrial plants, except maintenance of industrial

plants.....\$ 25.39	14.68
All other work, including maintenance of industrial plant.....\$ 25.39	14.68

FOOTNOTES: Spray painting, sandblasting, blowdown associated with spraying and blasting, water blasting and work involving a swing stage, boatswain chair or spider: \$1.00 per hour additional. All work performed inside tanks, vessels, tank trailers, railroad cars, sewers, smoke stacks, boilers or other spaces having limited egress not including buildings, opentop tanks, pits, etc.: \$1.25 per hour additional.

-----  
 PLAS0514-001 06/01/2018

ZONE 1: GENESEE, LIVINGSTON, MACOMB, MONROE, OAKLAND, SAGINAW, WASHTENAW AND WAYNE COUNTIES

ZONE 2: ALCONA, ALGER, ALLEGAN, ALPENA, ANTRIM, ARENAC, BARAGA, BARRY, BAY, BENZIE, BERRIEN, BRANCH, CALHOUN, CASS, CHARLEVOIX, CHEBOYGAN, CHIPPEWA, CLARE, CLINTON, CRAWFORD, DELTA, DICKINSON, EATON, EMMET, GLADWIN, GOGEBIC, GRAND TRAVERSE, GRATIOT, HILLSDALE, HOUGHTON, HURON, INGHAM, IONIA, IOSCO, IRON, ISABELLA, JACKSON, KALAMAZOO, KALKASKA, KENT, KEWEENAW, LAKE, LAPEER, LEELANAU, LENAWEE, LUCE, MACKINAC, MANISTEE, MARQUETTE, MASON, MECOSTA, MENOMINEE, MIDLAND, MISSAUKEE, MONTCALM, MONTMORENCY, MUSKEGON, NEWAYGO, OCEANA, OGEMAW, ONTONAGON, OSCEOLA, OSCODA, OTSEGO, OTTAWA, PRESQUE ISLE, ROSCOMMON, SANILAC, SCHOOLCRAFT, SHIAWASSEE, ST. CLAIR, ST. JOSEPH, TUSCOLA, VAN BUREN AND WEXFORD COUNTIES

Rates Fringes

CEMENT MASON/CONCRETE FINISHER		
ZONE 1.....	\$ 31.47	13.81
ZONE 2.....	\$ 29.97	13.81

-----  
 PLUM0190-003 05/01/2015

ALCONA, ALGER, ALLEGAN, ALPENA, ANTRIM, ARENAC, BARAGA, BARRY, BAY, BENZIE, BERRIEN, BRANCH, CALHOUN, CASS, CHARLEVOIX, CHEBOYGAN, CHIPPEWA, CLARE, CLINTON, CRAWFORD, DELTA, DICKINSON, EATON, EMMET, GENESEE, GLADWIN, GOGEBIC, GRAND TRAVERSE, GRATIOT, HILLSDALE, HOUGHTON, HURON, INGHAM, IONIA, IOSCO, IRON, ISABELLA, JACKSON, KALAMAZOO, KALKASKA, KENT, KEWEENAW, LAKE, LAPEER, LEELANAU, LENAWEE, LIVINGSTON, LUCE, MACKINAC, MACOMB, MANISTEE, MARQUETTE, MASON, MECOSTA, MENOMINEE, MIDLAND, MISSAUKEE, MONTCALM, MONTMORENCY, MONROE, MUSKEGON, NEWAYGO, OAKLAND, OCEANA, OGEMAW, ONTONAGON, OSCEOLA, OSCODA, OTSEGO, OTTAWA, PRESQUE ISLE, ROSCOMMON, SAGINAW, ST. CLARE, ST. JOSEPH, SANILAC, SCHOOLCRAFT, SHIAWASSEE, TUSCOLA, VAN BUREN, WASHTENAW, WAYNE AND WEXFORD COUNTIES

Rates Fringes

Plumber/Pipefitter - gas distribution pipeline:		
Welding in conjunction with gas distribution pipeline work.....		
	\$ 33.03	20.19
All other work:.....	\$ 24.19	12.28

-----  
 TEAM0007-004 06/01/2020

AREA 1: ALCONA, ALGER, ALLEGAN, ALPENA, ANTRIM, ARENAC, BARAGA, BARRY, BAY, BENZIE, BERRIEN, BRANCH, CALHOUN, CASS, CHARLEVOIX, CHEBOYGAN, CHIPPEWA, CLARE, CLINTON, CRAWFORD, DELTA, DICKINSON, EATON, EMMET, GLADWIN, GOGEBIC, GRAND TRAVERSE, GRATIOT, HILLSDALE, HOUGHTON, HURON, INGHAM, IONIA, IOSCO, IRON, ISABELLA, JACKSON, KALAMAZOO, KALKASKA, KENT, KEWEENAW, LAKE, LAPEER, LEELANAU, LENAWEE, LUCE, MACKINAC, MANISTEE, MARQUETTE, MASON, MECOSTA, MENOMINEE, MIDLAND, MISSAUKEE, MONTCALM, MONTMORENCY, MUSKEGON, NEWAYGO, OCEANA, OGEMAW, ONTONAGON, OSCEOLA, OSCODA, OTSEGO, OTTAWA, PRESQUE ISLE, ROSCOMMON, SAGINAW, SANILAC, SCHOOLCRAFT, SHIAWASSEE, ST. CLAIR, ST. JOSEPH, TUSCOLA, VAN BUREN AND WEXFORD COUNTIES

AREA 2: GENESEE, LIVINGSTON, MACOMB, MONROE, OAKLAND, WASHTENAW AND WAYNE COUNTIES

Rates Fringes

TRUCK DRIVER		
AREA 1		
Euclids, double bottoms and lowboys.....	\$ 28.05	.50 + a+b
Trucks under 8 cu. yds.....	\$ 27.80	.50 + a+b
Trucks, 8 cu. yds. and over.....	\$ 27.90	.50 + a+b
AREA 2		
Euclids, double bottomms and lowboys.....	\$ 24.895	.50 + a+b
Euclids, double bottoms		

and lowboys.....	\$ 28.15	.50 + a+b
Trucks under 8 cu. yds.....	\$ 27.90	.50 + a+b
Trucks, 8 cu. yds. and over.....	\$ 28.00	.50 + a+b

Footnote:

- a. \$47.70 per week
- b. \$68.70 daily

-----  
 TEAM0247-004 04/01/2013

AREA 1: ALCONA, ALGER, ALLEGAN, ALPENA, ANTRIM, ARENAC, BARAGA, BARRY, BAY, BENZIE, BERRIEN, BRANCH, CALHOUN, CASS, CHARLEVOIX, CHEBOYGAN, CHIPPEWA, CLARE, CLINTON, CRAWFORD, DELTA, DICKINSON, EATON, EMMET, GLADWIN, GOGEBIC, GRAND TRAVERSE, GRATIOT, HILLSDALE, HOUGHTON, HURON, INGHAM, IONIA, IOSCO, IRON, ISABELLA, JACKSON, KALAMAZOO, KALKASKA, KENT, KEWEENAW, LAKE, LAPEER, LEELANAU, LENAWEE, LUCE, MACKINAC, MANISTEE, MARQUETTE, MASON, MECOSTA, MENOMINEE, MIDLAND, MISSAUKEE, MONTCALM, MONTMORENCY, MUSKEGON, NEWAYGO, OCEANA, OGEMAW, ONTONAGON, OSCEOLA, OSCODA, OTSEGO, OTTAWA, PRESQUE ISLE, ROSCOMMON, SANILAC, SCHOOLCRAFT, SHIAWASSEE, SAGINAW, ST. CLAIR, ST. JOSEPH, TUSCOLA, VAN BUREN AND WEXFORD COUNTIES

AREA 2: GENESEE, LIVINGSTON, MACOMB, MONROE, OAKLAND, WASHTENAW AND WAYNE COUNTIES

Rates      Fringes

Sign Installer

AREA 1		
GROUP 1.....	\$ 21.78	11.83
GROUP 2.....	\$ 25.27	11.8375
AREA 2		
GROUP 1.....	\$ 22.03	11.83
GROUP 2.....	\$ 25.02	11.8375

FOOTNOTE:

- a. \$132.70 per week, plus \$17.80 per day.

SIGN INSTALLER CLASSIFICATIONS:

GROUP 1: performs all necessary labor and uses all tools required to construct and set concrete forms required in the installation of highway and street signs

GROUP 2: performs all miscellaneous labor, uses all hand and power tools, and operates all other equipment, mobile or otherwise, required for the installation of highway and street signs

-----  
 TEAM0247-010 04/01/2018

AREA 1: LAPEER AND SHIAWASSEE COUNTIES

AREA 2: GENESEE, MACOMB, MONROE, OAKLAND, ST. CLAIR, WASHTENAW AND WAYNE COUNTIES

Rates      Fringes

TRUCK DRIVER (Underground construction)

AREA 1

GROUP 1.....	\$ 23.82	19.04
GROUP 2.....	\$ 23.91	19.04
GROUP 3.....	\$ 24.12	19.04

AREA 2

GROUP 1.....	\$ 24.12	19.04
GROUP 2.....	\$ 24.26	19.04
GROUP 3.....	\$ 24.45	19.04

PAID HOLIDAYS: New Year's Day, Memorial Day, Fourth of July, Labor Day, Thanksgiving Day and Christmas Day.

SCOPE OF WORK: Excavation, site preparation, land balancing, grading, sewers, utilities and improvements; also including but not limited to, tunnels, underground piping, retention, oxidation, flocculation facilities, conduits, general excavation and steel sheeting for underground construction. Underground construction work shall not include any structural modifications, alterations, additions and repairs to buildings or highway work, including roads, streets, bridge construction and parking lots or steel erection.

TRUCK DRIVER CLASSIFICATIONS

GROUP 1: Truck driver on all trucks (EXCEPT dump trucks of 8 cubic yards capacity or over, pole trailers, semis, low boys, Euclid, double bottom and fuel trucks)

GROUP 2: Truck driver on dump trucks of 8 cubic yards capacity or over, pole trailers, semis and fuel trucks

GROUP 3: Truck driver on low boy, Euclid and double bottom

-----  
SUMI2002-001 05/01/2002

	Rates	Fringes
Flag Person.....	\$ 10.10	0.00
LINE PROTECTOR (ZONE 1: GENESEE, MACOMB, MONROE, OAKLAND, WASHTENAW AND WAYNE)....	\$ 20.30	12.90

LINE PROTECTOR (ZONE 2: STATEWIDE (EXCLUDING GENESEE, MACOMB, MONROE, OAKLAND, WASHTENAW AND WAYNE).....	\$ 18.02	12.90
---	----------	-------

Pavement Marking Machine (ZONE 1: GENESEE, MACOMB, MONROE, OAKLAND, WASHTENAW AND WAYNE COUNTIES) Group 1.....	\$ 27.07	12.90
--	----------	-------

Pavement Marking Machine  
(ZONE 1: GENESEE, MACOMB,  
MONROE, OAKLAND, WASHTENAW  
AND WAYNE)

Group 2.....\$ 24.36 12.90

Pavement Marking Machine
(ZONE 2: STATEWIDE (EXCLUDING
GENESEE, MACOMB, MONROE,
OAKLAND, WASHTENAW AND WAYNE
COUNTIES)

Group 1.....\$ 24.02 12.90

Pavement Marking Machine
(ZONE 2: STATEWIDE (EXCLUDING
GENESEE, MACOMB, MONROE,
OAKLAND, WASHTENAW AND WAYNE)

Group 2.....\$ 21.62 12.90

WORK CLASSIFICATIONS:

PAVEMENT MARKER GROUP 1: Drives or operates a truck mounted
striper, grinder, blaster, groover, or thermoplastic melter
for the placement or removal of temporary or permanent
pavement markings or markers.

PAVEMENT MARKER GROUP 2: Performs all functions involved for
the placement or removal of temporary or permanent pavement
markings or markers not covered by the classification of
Pavement Marker Group 1 or Line Protector.

LINE PROTECTOR: Performs all operations for the protection or
removal of temporary or permanent pavement markings or
markers in a moving convoy operation not performed by the
classification of Pavement Marker Group 1. A moving convoy
operation is comprised of only Pavement Markers Group 1 and
Line Protectors.

WELDERS - Receive rate prescribed for craft performing
operation to which welding is incidental.

Note: Executive Order (EO) 13706, Establishing Paid Sick Leave
for Federal Contractors applies to all contracts subject to the
Davis-Bacon Act for which the contract is awarded (and any
solicitation was issued) on or after January 1, 2017. If this
contract is covered by the EO, the contractor must provide
employees with 1 hour of paid sick leave for every 30 hours
they work, up to 56 hours of paid sick leave each year.
Employees must be permitted to use paid sick leave for their
own illness, injury or other health-related needs, including
preventive care; to assist a family member (or person who is
like family to the employee) who is ill, injured, or has other
health-related needs, including preventive care; or for reasons
resulting from, or to assist a family member (or person who is
like family to the employee) who is a victim of, domestic
violence, sexual assault, or stalking. Additional information
on contractor requirements and worker protections under the EO
is available at www.dol.gov/whd/govcontracts.

Unlisted classifications needed for work not included within
the scope of the classifications listed may be added after
award only as provided in the labor standards contract clauses
(29CFR 5.5 (a) (1) (ii)).

-----

The body of each wage determination lists the classification and wage rates that have been found to be prevailing for the cited type(s) of construction in the area covered by the wage determination. The classifications are listed in alphabetical order of ""identifiers"" that indicate whether the particular rate is a union rate (current union negotiated rate for local), a survey rate (weighted average rate) or a union average rate (weighted union average rate).

#### Union Rate Identifiers

A four letter classification abbreviation identifier enclosed in dotted lines beginning with characters other than ""SU"" or ""UAVG"" denotes that the union classification and rate were prevailing for that classification in the survey. Example: PLUM0198-005 07/01/2014. PLUM is an abbreviation identifier of the union which prevailed in the survey for this classification, which in this example would be Plumbers. 0198 indicates the local union number or district council number where applicable, i.e., Plumbers Local 0198. The next number, 005 in the example, is an internal number used in processing the wage determination. 07/01/2014 is the effective date of the most current negotiated rate, which in this example is July 1, 2014.

Union prevailing wage rates are updated to reflect all rate changes in the collective bargaining agreement (CBA) governing this classification and rate.

#### Survey Rate Identifiers

Classifications listed under the ""SU"" identifier indicate that no one rate prevailed for this classification in the survey and the published rate is derived by computing a weighted average rate based on all the rates reported in the survey for that classification. As this weighted average rate includes all rates reported in the survey, it may include both union and non-union rates. Example: SULA2012-007 5/13/2014. SU indicates the rates are survey rates based on a weighted average calculation of rates and are not majority rates. LA indicates the State of Louisiana. 2012 is the year of survey on which these classifications and rates are based. The next number, 007 in the example, is an internal number used in producing the wage determination. 5/13/2014 indicates the survey completion date for the classifications and rates under that identifier.

Survey wage rates are not updated and remain in effect until a new survey is conducted.

#### Union Average Rate Identifiers

Classification(s) listed under the UAVG identifier indicate that no single majority rate prevailed for those classifications; however, 100% of the data reported for the classifications was union data. EXAMPLE: UAVG-OH-0010 08/29/2014. UAVG indicates that the rate is a weighted union average rate. OH indicates the state. The next number, 0010 in the example, is an internal number used in producing the wage

determination. 08/29/2014 indicates the survey completion date for the classifications and rates under that identifier.

A UAVG rate will be updated once a year, usually in January of each year, to reflect a weighted average of the current negotiated/CBA rate of the union locals from which the rate is based.

-----  
WAGE DETERMINATION APPEALS PROCESS

1.) Has there been an initial decision in the matter? This can be:

- \* an existing published wage determination
- \* a survey underlying a wage determination
- \* a Wage and Hour Division letter setting forth a position on a wage determination matter
- \* a conformance (additional classification and rate) ruling

On survey related matters, initial contact, including requests for summaries of surveys, should be with the Wage and Hour Regional Office for the area in which the survey was conducted because those Regional Offices have responsibility for the Davis-Bacon survey program. If the response from this initial contact is not satisfactory, then the process described in 2.) and 3.) should be followed.

With regard to any other matter not yet ripe for the formal process described here, initial contact should be with the Branch of Construction Wage Determinations. Write to:

Branch of Construction Wage Determinations  
Wage and Hour Division  
U.S. Department of Labor  
200 Constitution Avenue, N.W.  
Washington, DC 20210

2.) If the answer to the question in 1.) is yes, then an interested party (those affected by the action) can request review and reconsideration from the Wage and Hour Administrator (See 29 CFR Part 1.8 and 29 CFR Part 7). Write to:

Wage and Hour Administrator  
U.S. Department of Labor  
200 Constitution Avenue, N.W.  
Washington, DC 20210

The request should be accompanied by a full statement of the interested party's position and by any information (wage payment data, project description, area practice material, etc.) that the requestor considers relevant to the issue.

3.) If the decision of the Administrator is not favorable, an interested party may appeal directly to the Administrative Review Board (formerly the Wage Appeals Board). Write to:

Administrative Review Board  
U.S. Department of Labor  
200 Constitution Avenue, N.W.  
Washington, DC 20210

4.) All decisions by the Administrative Review Board are final.

=====  
END OF GENERAL DECISION"